

---

Digital Cinema Initiatives, LLC

# **Digital Cinema System Specification**

**Version 1.2 with Errata as of 30 August 2012 Incorporated**

Approved 10 October 2012

Digital Cinema Initiatives, LLC, Member Representatives Committee

Copyright © 2005-2012

Digital Cinema Initiatives, LLC

---

# NOTICE

Digital Cinema Initiatives, LLC (DCI) is the author and creator of this specification for the purpose of copyright and other laws in all countries throughout the world. The DCI copyright notice must be included in all reproductions, whether in whole or in part, and may not be deleted or attributed to others. DCI hereby grants to its members and their suppliers a limited license to reproduce this specification for their own use, provided it is not sold. Others should obtain permission to reproduce this specification from Digital Cinema Initiatives, LLC.

This document is a specification developed and adopted by Digital Cinema Initiatives, LLC. This document may be revised by DCI. It is intended solely as a guide for companies interested in developing products, which can be compatible with other products, developed using this document. Each DCI member company shall decide independently the extent to which it will utilize, or require adherence to, these specifications. DCI shall not be liable for any exemplary, incidental, proximate or consequential damages or expenses arising from the use of this document. This document defines only one approach to compatibility, and other approaches may be available to the industry.

This document is an authorized and approved publication of DCI. Only DCI has the right and authority to revise or change the material contained in this document, and any revisions by any party other than DCI are unauthorized and prohibited.

Compliance with this document may require use of one or more features covered by proprietary rights (such as features which are the subject of a patent, patent application, copyright, mask work right or trade secret right). By publication of this document, no position is taken by DCI with respect to the validity or infringement of any patent or other proprietary right. DCI hereby expressly disclaims any liability for infringement of intellectual property rights of others by virtue of the use of this document. DCI has not and does not investigate any notices or allegations of infringement prompted by publication of any DCI document, nor does DCI undertake a duty to advise users or potential users of DCI documents of such notices or allegations. DCI hereby expressly advises all users or potential users of this document to investigate and analyze any potential infringement situation, seek the advice of intellectual property counsel, and, if indicated, obtain a license under any applicable intellectual property right or take the necessary steps to avoid infringement of any intellectual property right. DCI expressly disclaims any intent to promote infringement of any intellectual property right by virtue of the evolution, adoption, or publication of this document.

---

# Table of Contents

<b>1.</b>	<b>OVERVIEW</b>	<b>13</b>
<b>1.1.</b>	<b>Introduction</b>	<b>13</b>
<b>1.2.</b>	<b>Scope</b>	<b>13</b>
<b>1.3.</b>	<b>Document Language</b>	<b>14</b>
<b>1.4.</b>	<b>System Objectives</b>	<b>15</b>
<b>2.</b>	<b>SYSTEM OVERVIEW</b>	<b>17</b>
<b>2.1.</b>	<b>Functional Framework</b>	<b>17</b>
<b>2.1.1.</b>	<b>Major System Concepts</b>	<b>20</b>
2.1.1.1.	Digital Source Master (DSM)	20
2.1.1.2.	Composition	20
2.1.1.3.	Digital Cinema Distribution Master (DCDM)	20
2.1.1.4.	Digital Cinema Package (DCP)	20
2.1.1.5.	Hierarchical Image Structure	21
2.1.1.6.	File / Frame-Based System	21
2.1.1.7.	Store and Forward	22
2.1.1.8.	Reels	22
2.1.1.9.	Component Design	22
2.1.1.10.	Storage and Media Block	22
<b>3.</b>	<b>DIGITAL CINEMA DISTRIBUTION MASTER</b>	<b>23</b>
<b>3.1.</b>	<b>Overview</b>	<b>23</b>
<b>3.1.1.</b>	<b>Introduction</b>	<b>23</b>
<b>3.1.2.</b>	<b>DCDM System Overview</b>	<b>23</b>
<b>3.1.3.</b>	<b>Major DCDM Concepts</b>	<b>23</b>
<b>3.1.4.</b>	<b>DCDM Fundamental Requirements</b>	<b>24</b>
3.1.4.1.	Common File Formats	24
3.1.4.2.	Frame Rates	24
3.1.4.3.	Synchronization	24
<b>3.2.</b>	<b>Image Specification</b>	<b>24</b>
<b>3.2.1.</b>	<b>Image Concepts and Requirements</b>	<b>24</b>
<b>3.2.2.</b>	<b>DCDM Image File Format</b>	<b>25</b>
3.2.2.1.	Introduction	25
3.2.2.2.	File Mapping	25
3.2.2.3.	Synchronization	25
3.2.2.4.	Image Metadata Required Fields	26
<b>3.3.</b>	<b>Audio Specification</b>	<b>26</b>
<b>3.3.1.</b>	<b>Audio Concepts and Requirements</b>	<b>26</b>
<b>3.3.2.</b>	<b>Audio Characteristics</b>	<b>26</b>
<b>3.3.3.</b>	<b>Channel Mapping</b>	<b>26</b>
<b>3.3.4.</b>	<b>File Format</b>	<b>27</b>
3.3.4.1.	General	27
3.3.4.2.	Synchronization	27
<b>3.4.</b>	<b>Text Rendering</b>	<b>27</b>
<b>3.4.1.</b>	<b>Text Rendering Concepts and Requirements</b>	<b>27</b>
<b>3.4.2.</b>	<b>Subpicture</b>	<b>28</b>

3.4.2.1.	Introduction.....	28
3.4.2.2.	File Format.....	28
3.4.2.3.	Rendering Intent .....	28
3.4.2.4.	Frame Rate and Timing .....	28
3.4.2.5.	Synchronization.....	28
<b>3.4.3.</b>	<b>Timed Text Concepts and Requirements.....</b>	<b>29</b>
3.4.3.1.	Introduction.....	29
3.4.3.2.	File Format.....	29
3.4.3.3.	Restart .....	29
3.4.3.4.	Default Font.....	29
3.4.3.5.	Identification .....	29
3.4.3.6.	Searchability .....	29
3.4.3.7.	Multiple Captions .....	30
3.4.3.8.	Synchronization.....	30
<b>3.4.4.</b>	<b>Show Control Concepts and Requirements .....</b>	<b>30</b>
<b>3.4.5.</b>	<b>Show Controls .....</b>	<b>30</b>
3.4.5.1.	Introduction.....	30
<b>4.</b>	<b>COMPRESSION</b>	<b>31</b>
<b>4.1.</b>	<b>Introduction .....</b>	<b>31</b>
<b>4.2.</b>	<b>Compression Standard .....</b>	<b>31</b>
<b>4.3.</b>	<b>Decoder Specification .....</b>	<b>31</b>
4.3.1.	Definitions.....	31
4.3.2.	Decoder Requirements .....	31
<b>4.4.</b>	<b>Codestream Specification.....</b>	<b>32</b>
<b>5.</b>	<b>PACKAGING</b>	<b>35</b>
<b>5.1.</b>	<b>Introduction .....</b>	<b>35</b>
<b>5.2.</b>	<b>Packaging System Overview .....</b>	<b>35</b>
5.2.1.	Functional Framework .....	35
5.2.2.	Packaging Fundamental Requirements.....	35
5.2.2.1.	Introduction.....	35
5.2.2.2.	Open Standard .....	36
5.2.2.3.	Interoperable.....	36
5.2.2.4.	Scalable.....	36
5.2.2.5.	Supports Essential Business Functions.....	36
5.2.2.6.	Secure .....	36
5.2.2.7.	Extensible .....	36
5.2.2.8.	Synchronization.....	36
5.2.2.9.	Human Readable Metadata .....	36
5.2.2.10.	Identity .....	36
<b>5.2.3.</b>	<b>Packaging Concepts .....</b>	<b>37</b>
<b>5.3.</b>	<b>Composition .....</b>	<b>39</b>
5.3.1.	Track File Concepts and Requirements .....	39
5.3.1.1.	Introduction.....	39
5.3.1.2.	Format Information.....	40
5.3.1.3.	Reel.....	40
5.3.1.4.	Track File Replacement .....	40
5.3.1.5.	Synchronization.....	41

5.3.1.6.	Splicing.....	41
5.3.1.7.	Key Epoch .....	41
5.3.1.8.	Security.....	41
5.3.1.9.	Integrity and Authentication .....	41
5.3.1.10.	Extensibility .....	41
5.3.1.11.	Random Access and Restarts .....	42
5.3.1.12.	Simple Essence .....	42
<b>5.3.2.</b>	<b>MXF Track File Encryption .....</b>	<b>42</b>
5.3.2.1.	Introduction.....	42
5.3.2.2.	Encrypted Track File Constraints.....	42
<b>5.3.3.</b>	<b>Image Track File.....</b>	<b>42</b>
5.3.3.1.	Introduction.....	42
5.3.3.2.	Frame Boundaries .....	43
5.3.3.3.	Compression.....	43
5.3.3.4.	Metadata .....	43
<b>5.3.4.</b>	<b>Audio Track File .....</b>	<b>43</b>
5.3.4.1.	Introduction.....	43
5.3.4.2.	Frame Boundaries .....	43
5.3.4.3.	Data Packing Format .....	43
5.3.4.4.	Metadata .....	43
<b>5.3.5.</b>	<b>Subtitle Track File .....</b>	<b>44</b>
5.3.5.1.	Introduction.....	44
5.3.5.2.	Frame Boundaries .....	44
5.3.5.3.	Timed Text.....	44
5.3.5.4.	Subpicture .....	44
5.3.5.5.	Metadata .....	44
<b>5.3.6.</b>	<b>Auxiliary Track Files and Extensibility .....</b>	<b>45</b>
<b>5.4.</b>	<b>Composition Playlists .....</b>	<b>45</b>
<b>5.4.1.</b>	<b>Introduction .....</b>	<b>45</b>
<b>5.4.2.</b>	<b>File Format .....</b>	<b>45</b>
<b>5.4.3.</b>	<b>Human Readable Information .....</b>	<b>45</b>
5.4.3.1.	General Information.....	45
5.4.3.2.	Image Track Information (list for each reel).....	45
5.4.3.3.	Audio Track Information (list for each reel).....	46
5.4.3.4.	Subtitle Track Information if Present (list for each reel).....	46
5.4.3.5.	[Removed] .....	46
5.4.3.6.	Digital Signature .....	46
<b>5.4.4.</b>	<b>Security of the CPL.....</b>	<b>46</b>
<b>5.5.</b>	<b>Distribution Package.....</b>	<b>46</b>
<b>5.5.1.</b>	<b>Introduction .....</b>	<b>46</b>
<b>5.5.2.</b>	<b>Distribution Package.....</b>	<b>47</b>
5.5.2.1.	General.....	47
5.5.2.2.	Packing for Transport .....	47
5.5.2.3.	Security.....	47
<b>5.5.3.</b>	<b>Packing List.....</b>	<b>47</b>
5.5.3.1.	File Format.....	47
5.5.3.2.	Fields.....	47

<b>6.</b>	<b>TRANSPORT</b>	<b>49</b>
<b>6.1.</b>	<b>Introduction</b>	<b>49</b>
<b>6.2.</b>	<b>Transport System Overview</b>	<b>49</b>
<b>6.2.1.</b>	<b>Transport Fundamental Requirements</b>	<b>49</b>
6.2.1.1.	Introduction	49
6.2.1.2.	Security	49
6.2.1.3.	Robustness	49
<b>6.2.2.</b>	<b>Transport Fundamental Concepts</b>	<b>49</b>
<b>6.2.3.</b>	<b>Ingest Interface</b>	<b>49</b>
<b>7.</b>	<b>THEATER SYSTEMS</b>	<b>51</b>
<b>7.1.</b>	<b>Introduction</b>	<b>51</b>
<b>7.2.</b>	<b>Theater System Overview</b>	<b>51</b>
<b>7.2.1.</b>	<b>Functional Framework</b>	<b>51</b>
<b>7.2.2.</b>	<b>Theater System Major Concepts</b>	<b>51</b>
<b>7.2.3.</b>	<b>Theater System Fundamental Requirements</b>	<b>52</b>
7.2.3.1.	Reliability	52
7.2.3.2.	Mean Time to Repair	52
7.2.3.3.	Test Shows	52
7.2.3.4.	Monitoring and Diagnostics	52
7.2.3.5.	Easy Assembly of Content	52
7.2.3.6.	Movement of Content	52
7.2.3.7.	Ease of Operation	52
7.2.3.8.	Multiple Systems	53
7.2.3.9.	Environment	53
7.2.3.10.	Safety	53
7.2.3.11.	Storage Capacity Per Screen	53
7.2.3.12.	Persistent Security	53
7.2.3.13.	Power Failure	53
7.2.3.14.	Local Control	53
<b>7.3.</b>	<b>Show Playlist</b>	<b>53</b>
<b>7.3.1.</b>	<b>Introduction</b>	<b>53</b>
<b>7.3.2.</b>	<b>File Format</b>	<b>53</b>
<b>7.3.3.</b>	<b>Human Readable Information</b>	<b>54</b>
7.3.3.1.	General Information	54
7.3.3.2.	Sequence of Composition Playlists	54
<b>7.3.4.</b>	<b>Editing Show Playlist</b>	<b>54</b>
<b>7.4.</b>	<b>Theater Management Systems</b>	<b>54</b>
<b>7.4.1.</b>	<b>Operation</b>	<b>54</b>
7.4.1.1.	Introduction	54
7.4.1.2.	Local Control	55
7.4.1.3.	User Accounts	55
7.4.1.4.	Receipt of Content	56
7.4.1.5.	Movement of Content	56
7.4.1.6.	Assembly of Content	56
7.4.1.7.	Automation Programming	57
7.4.1.8.	Playback of Content	57
<b>7.4.2.</b>	<b>Theater Management System Events</b>	<b>58</b>

---

<b>7.5.</b>	<b>Theater Systems Architectures .....</b>	<b>58</b>
<b>7.5.1.</b>	<b>Introduction .....</b>	<b>58</b>
<b>7.5.2.</b>	<b>Ingest .....</b>	<b>58</b>
7.5.2.1.	Introduction.....	58
7.5.2.2.	Ingest Interfaces.....	61
7.5.2.3.	Firewalls.....	61
<b>7.5.3.</b>	<b>Storage.....</b>	<b>61</b>
7.5.3.1.	Introduction.....	61
7.5.3.2.	Storage Reliability.....	61
7.5.3.3.	Central Storage.....	62
7.5.3.4.	Local Storage .....	62
7.5.3.5.	Combined Central and Local Storage .....	62
7.5.3.6.	Bandwidth .....	62
7.5.3.7.	Capacity .....	62
7.5.3.8.	Storage Security .....	63
<b>7.5.4.</b>	<b>Media Block.....</b>	<b>63</b>
7.5.4.1.	Introduction.....	63
7.5.4.2.	Media Block Functional Requirements .....	65
7.5.4.2.1.	Synchronization .....	65
7.5.4.2.2.	Security Functions.....	65
7.5.4.2.3.	Image Link Encryption and Decryptor Block.....	65
7.5.4.2.4.	Unpackaging .....	65
7.5.4.2.5.	Alpha Channel Overlay.....	65
7.5.4.2.6.	Subpicture Renderer.....	66
7.5.4.2.7.	Timed Text Renderer .....	66
7.5.4.3.	Media Block Interfaces.....	66
<b>7.5.5.</b>	<b>Projection System .....</b>	<b>67</b>
7.5.5.1.	Introduction.....	67
7.5.5.2.	Projection System Interfaces.....	67
<b>7.5.6.</b>	<b>Audio System.....</b>	<b>68</b>
7.5.6.1.	Introduction.....	68
7.5.6.2.	Audio System Interfaces.....	68
<b>7.5.7.</b>	<b>Screen Automation System .....</b>	<b>68</b>
7.5.7.1.	Introduction.....	68
7.5.7.2.	Automation Interface .....	68
<b>7.5.8.</b>	<b>Screen Management System (SMS) .....</b>	<b>69</b>
<b>7.5.9.</b>	<b>Multiplex Theater System Architecture .....</b>	<b>69</b>
7.5.9.1.	Introduction.....	69
7.5.9.2.	Media Network.....	69
7.5.9.3.	Theater Management Network.....	70
7.5.9.3.1.	Introduction .....	70
7.5.9.3.2.	Screen / Theater Management System (SMS/TMS) .....	70
7.5.9.3.3.	Storage.....	71
7.5.9.3.4.	Media Block .....	71
7.5.9.3.5.	Projection System .....	71
7.5.9.3.6.	Cinema Audio Processor .....	71
<b>8.</b>	<b>PROJECTION .....</b>	<b>73</b>

---

<b>8.1.</b>	<b>Introduction .....</b>	<b>73</b>
<b>8.2.</b>	<b>Projection System Overview.....</b>	<b>73</b>
<b>8.2.1.</b>	<b>Functional Framework .....</b>	<b>73</b>
<b>8.2.2.</b>	<b>Projection Fundamental Requirements .....</b>	<b>73</b>
8.2.2.1.	Introduction.....	73
8.2.2.2.	Interfaces.....	73
8.2.2.3.	Alternative Content.....	74
8.2.2.4.	Single Lens.....	74
8.2.2.5.	Color Space Conversion.....	74
8.2.2.6.	Pixel Count.....	74
8.2.2.7.	Spatial Resolution Conversion.....	74
8.2.2.8.	Refresh Rate .....	74
8.2.2.9.	Forensic Marking.....	74
8.2.2.10.	Media Block.....	75
<b>8.2.3.</b>	<b>Projection Concepts.....</b>	<b>75</b>
<b>8.3.</b>	<b>Projected Image and Viewing Environment for Digital Cinema Content .....</b>	<b>75</b>
<b>8.3.1.</b>	<b>Introduction .....</b>	<b>75</b>
<b>8.3.2.</b>	<b>Input .....</b>	<b>75</b>
<b>8.3.3.</b>	<b>Environment, Image Parameters and Projected Image Tolerances.....</b>	<b>75</b>
<b>8.4.</b>	<b>Projector Interfaces .....</b>	<b>76</b>
<b>8.4.1.</b>	<b>Introduction .....</b>	<b>76</b>
<b>8.4.2.</b>	<b>Media Block Interface .....</b>	<b>76</b>
<b>8.4.3.</b>	<b>Uncompressed Image Interface .....</b>	<b>76</b>
8.4.3.1.	Introduction.....	76
8.4.3.2.	Dual-Dual (Quad) Link HD-SDI .....	76
8.4.3.3.	Dual Link HD-SDI.....	77
8.4.3.4.	10 Gigabit Fiber .....	77
<b>8.4.4.</b>	<b>Graphics and Timed Text Interface .....</b>	<b>77</b>
<b>8.4.5.</b>	<b>Control and Status Interface.....</b>	<b>77</b>
8.4.5.1.	Control.....	77
8.4.5.2.	Status.....	78
<b>9.</b>	<b>SECURITY .....</b>	<b>79</b>
<b>9.1.</b>	<b>Introduction .....</b>	<b>79</b>
<b>9.2.</b>	<b>Fundamental Security System Requirements .....</b>	<b>80</b>
<b>9.2.1.</b>	<b>Content Protection and Piracy Prevention .....</b>	<b>80</b>
<b>9.2.2.</b>	<b>Single Inventory and Interoperability .....</b>	<b>80</b>
<b>9.2.3.</b>	<b>Reliability .....</b>	<b>81</b>
<b>9.2.4.</b>	<b>Support Forensics and Attack Detection .....</b>	<b>81</b>
<b>9.2.5.</b>	<b>Resist Threats .....</b>	<b>81</b>
<b>9.3.</b>	<b>Security Architecture Overview .....</b>	<b>81</b>
<b>9.3.1.</b>	<b>Definitions.....</b>	<b>81</b>
<b>9.3.2.</b>	<b>Security Management Approach to Security .....</b>	<b>82</b>
<b>9.3.3.</b>	<b>Security Messaging and Security Entities .....</b>	<b>83</b>
9.3.3.1.	Security Messages .....	83
9.3.3.2.	Security Entities.....	84
<b>9.4.</b>	<b>Theater Systems Security .....</b>	<b>85</b>
<b>9.4.1.</b>	<b>Theater System Security Architecture.....</b>	<b>85</b>



9.4.1.1.	Architecture Description and Comments.....	86
<b>9.4.2.</b>	<b>Theater System Security Devices .....</b>	<b>90</b>
9.4.2.1.	Equipment Suites .....	90
9.4.2.2.	The Secure Processing Block (SPB).....	90
9.4.2.3.	Media Blocks (MBs).....	91
9.4.2.4.	Security Manager (SM).....	91
9.4.2.5.	Screen Management System (SMS) .....	92
9.4.2.6.	Projection Systems .....	93
<b>9.4.3.</b>	<b>Theater Security Operations.....</b>	<b>93</b>
9.4.3.1.	Transport Layer Security (TLS) Establishment and Secure Processing Block (SPB) Authentication.....	94
9.4.3.2.	Pre-show Preparations.....	95
9.4.3.3.	Show Playback.....	97
9.4.3.4.	Post Playback.....	98
9.4.3.5.	Functions of the Security Manager (SM).....	99
9.4.3.6.	Functional Requirements for Secure Processing Block Systems.....	103
9.4.3.6.1.	Normative Requirements: Projector Secure Processing Block.....	103
9.4.3.6.2.	Normative Requirements: Link Decryptor Block (LDB).....	104
9.4.3.6.3.	Normative Requirements: Image Media Block (IMB).....	106
9.4.3.6.4.	Normative Requirements: Audio Media Block .....	107
9.4.3.6.5.	Projector Authentication .....	107
9.4.3.6.6.	Permanently Married Implementations .....	108
9.4.3.7.	Theater System Clocks and Trustable Date-Time.....	109
<b>9.4.4.</b>	<b>Link Encryption .....</b>	<b>110</b>
9.4.4.1.	Special Auditorium Situations .....	111
<b>9.4.5.</b>	<b>Intra-Theater Communications.....</b>	<b>112</b>
9.4.5.1.	Transport Layer Security Sessions, End Points and Intra-Theater Messaging .....	112
9.4.5.2.	Intra-Theater Message Definitions.....	112
9.4.5.2.1.	Intra-theater Message Hierarchy.....	112
9.4.5.2.2.	Terms and Abbreviations.....	113
9.4.5.2.3.	General RRP Requirements.....	113
9.4.5.2.4.	Request-Response Pairs (RRP).....	114
9.4.5.3.	Intra-Theater Message Details .....	115
9.4.5.3.1.	Screen Management System to Security Manager Messages.....	115
9.4.5.3.2.	Image Media Block Security Messaging.....	115
<b>9.4.6.</b>	<b>Forensics .....</b>	<b>117</b>
9.4.6.1.	Forensic Marking.....	118
9.4.6.1.1.	General Requirements.....	118
9.4.6.1.2.	Image/Picture Survivability Requirements .....	120
9.4.6.1.3.	Audio Survivability Requirements .....	120
9.4.6.2.	Forensic Marking Operations .....	121
9.4.6.3.	Logging Subsystem .....	122
9.4.6.3.1.	Logging Requirements .....	123
9.4.6.3.2.	Log Record and Report Format.....	124
9.4.6.3.3.	Log Signatures and Integrity Controls.....	124
9.4.6.3.4.	Security of Log Record Sequencing.....	125
9.4.6.3.5.	Log Upload Protocol over Theater Networks .....	125

---

9.4.6.3.6.	Log Filtering .....	125
9.4.6.3.7.	Security Log Reports .....	126
9.4.6.3.8.	Log Record Information .....	126
9.4.6.3.9.	FIPS 140-2 Audit Mechanism Requirements .....	128
9.4.6.3.10.	Logging Failures .....	129
<b>9.5.</b>	<b>Implementation Requirements.....</b>	<b>129</b>
<b>9.5.1.</b>	<b>Digital Certificates .....</b>	<b>129</b>
9.5.1.1.	Single Certificate Implementations .....	129
9.5.1.2.	Dual Certificate Implementations .....	130
<b>9.5.2.</b>	<b>Robustness and Physical Implementations .....</b>	<b>131</b>
9.5.2.1.	Device Perimeter Definitions .....	131
9.5.2.2.	Physical Security of Sensitive Data .....	131
9.5.2.3.	Repair and Renewal.....	132
9.5.2.4.	Specific Requirements for Type 2 Secure Processing Blocks .....	133
9.5.2.5.	FIPS 140-2 Requirements for Type 1 Secure Processing Blocks.....	134
9.5.2.6.	Critical Security Parameters and D-Cinema Security Parameters.....	137
9.5.2.7.	SPB Firmware Modifications .....	137
<b>9.5.3.</b>	<b>Screen Management System (SMS) .....</b>	<b>138</b>
<b>9.5.4.</b>	<b>Subtitle Processing.....</b>	<b>138</b>
<b>9.5.5.</b>	<b>Compliance Testing.....</b>	<b>138</b>
<b>9.5.6.</b>	<b>Communications Robustness.....</b>	<b>139</b>
<b>9.6.</b>	<b>Security Features and Trust Management.....</b>	<b>139</b>
<b>9.6.1.</b>	<b>Digital Rights Management .....</b>	<b>140</b>
9.6.1.1.	Digital Rights Management: Screen Management System.....	141
9.6.1.2.	Digital Rights Management: Security Manager (SM) .....	141
9.6.1.3.	Digital Rights Management: Security Entity (SE) Equipment .....	142
<b>9.6.2.</b>	<b>“Trust” and the Trusted Device List (TDL).....</b>	<b>142</b>
9.6.2.1.	Trust Domains .....	143
9.6.2.2.	Authenticating Secure Processing Blocks & Linking Trust Through Certificates .....	144
9.6.2.3.	Identity vs. “Trust” .....	144
9.6.2.4.	Revocation and Renewal of Trust.....	145
<b>9.7.</b>	<b>Essence Encryption and Cryptography .....</b>	<b>145</b>
<b>9.7.1.</b>	<b>Content Transport .....</b>	<b>145</b>
<b>9.7.2.</b>	<b>Image and Sound Encryption.....</b>	<b>145</b>
<b>9.7.3.</b>	<b>Subtitle Encryption .....</b>	<b>145</b>
<b>9.7.4.</b>	<b>Protection of Content Keys.....</b>	<b>146</b>
<b>9.7.5.</b>	<b>Integrity Check Codes .....</b>	<b>146</b>
<b>9.7.6.</b>	<b>Key Generation and Derivation .....</b>	<b>146</b>
<b>9.7.7.</b>	<b>Numbers of Keys.....</b>	<b>147</b>
<b>9.8.</b>	<b>Digital Certificate, Extra-Theater Messages (ETM), and Key Delivery Messages (KDM) Requirements .....</b>	<b>147</b>
<b>10.</b>	<b>GLOSSARY OF TERMS</b>	<b>149</b>

---

---

## Table of Figures

Figure 1: System Overview Functional Encode Flow .....	18
Figure 2: System Overview Functional Decode Flow .....	19
Figure 3: Hierarchical Image Structure .....	21
Figure 4: This figure left blank intentionally .....	26
Figure 5: Example Composition Playlist .....	37
Figure 6: Example Show Playlist.....	38
Figure 7: Example Distribution Package .....	39
Figure 8: Example Track File Structure .....	39
Figure 9: Example of KLV Coding .....	40
Figure 10: Single-Screen System Architecture .....	60
Figure 11: Media Block Server Configuration .....	64
Figure 12: Media Block in Projector Configuration.....	64
Figure 13: Multiplex Theater System Architecture.....	72
Figure 14: Digital Cinema Security Message Flow .....	84
Figure 15: Digital Cinema Auditorium Security Implementations .....	89
Figure 16: System Start-Up Overview .....	95
Figure 17: Pre-Show Overview.....	96
Figure 18: Show Playback Overview .....	98
Figure 19: Post Playback Overview .....	99

---

## Table of Tables

Table 1: This table left blank intentionally.....	25
Table 2: This table left blank intentionally.....	25
Table 3: This table left blank intentionally.....	25
Table 4: Required Image Structure Information.....	26
Table 5: This table left blank intentionally.....	26
Table 6: This table left blank intentionally.....	26
Table 7: Codestream Structure .....	33
Table 8: Examples of Theater Management System Events.....	58
Table 9: Example of Storage Capacity for one 3-Hour Feature (12 bits @ 24 FPS) .....	63
Table 10: Examples of Screen Management System Events .....	69
Table 11: This table left blank intentionally.....	75
Table 12: This table left blank intentionally.....	75
Table 13: This table left blank intentionally.....	75
Table 14: This table left blank intentionally.....	75
Table 15: Intra-theater Message (ITM) Request-Response Pairs (RRP).....	115
Table 16: Left Intentionally Blank .....	117
Table 17: Left Intentionally Blank .....	117
Table 18: Left Intentionally Blank .....	117
Table 19 Security Log Event Types and Subtypes .....	127
Table 20: Summary of FIPS 140-2 Security Requirements.....	136
Table 21: Examples of Security Manager Events .....	141
Table 22: Examples of Failure or Tampering of Security Equipment.....	142
Table 23: Factors Supporting Trust in a Security Device.....	143

---

# 1. OVERVIEW

## 1.1. Introduction

A number of significant technology developments have occurred in the past few years that have enabled the digital playback and display of feature films at a level of quality commensurate with that of 35mm film release prints. These technology developments include the introduction of: high-resolution film scanners, digital image compression, high-speed data networking and storage, and advanced digital projection. The combination of these digital technologies has allowed many impressive demonstrations of what is now called “Digital Cinema” These demonstrations, however, have not incorporated all of the components necessary for a broad-based commercially viable Digital Cinema system. These demonstrations have created a great deal of discussion and confusion around defining the quality levels, system specifications, and the engineering standards necessary for implementing a comprehensive Digital Cinema system.

Digital Cinema Initiatives, LLC (DCI) is the entity created by seven motion picture studios: Disney, Fox, Metro-Goldwyn-Mayer<sup>1</sup>, Paramount Pictures, Sony Pictures Entertainment, Universal Studios, and Warner Bros. Studios. The primary purpose of DCI is to establish uniform specifications for Digital Cinema. These DCI member companies believe that the introduction of Digital Cinema has the potential for providing real benefits to theater audiences, theater owners, filmmakers and distributors. DCI was created with recognition that these benefits could not be fully realized without industry-wide specifications. All parties involved in the practice of Digital Cinema must be confident that their products and services are interoperable and compatible with the products and services of all industry participants. The DCI member companies further believe that Digital Cinema exhibition will significantly improve the movie-going experience for the public.

## 1.2. Scope

The document defines technical specifications and requirements for the mastering of, distribution of, and theatrical playback of Digital Cinema content. The details are in the following sections:

- **Digital Cinema Distribution Master (DCDM):** This section provides specifications for the image, audio, subtitle (Timed Text and subpictures) Digital Cinema Distribution Masters. The DCDM-Image defines a common set of image structures for Digital Cinema by specifying an image containers and colorimetry for a Digital Cinema Distribution Master (DCDM). The DCDM-Audio specifies the following characteristics: bit depth, sample rate, minimum channel count, channel mapping and reference levels. The DCDM-subtitles specifies the format of a Digital Cinema subtitle track file. A subtitle track file contains a set of instructions for placing rendered text or graphical overlays at precise locations on distinct groups of motion picture frames. A subtitle track file is an integral component of a Digital Cinema composition and may be present in both mastering and distribution file sets.

---

<sup>1</sup> Metro-Goldwyn-Mayer withdrew as a Member of DCI in May 2005, prior to the completion of this Specification

- 
- **Compression (Image):** Specifies the DCI compliant JPEG 2000 codestream and JPEG 2000 decoder.
  - **Packaging:** This section defines the requirements for packaging the DCDM (image, audio and subtitle) files using (where possible) existing Material eXchange Format (MXF) specifications and eXtensible Mark up Language (XML). The output of this process is the Digital Cinema Package (DCP). This section also defines the requirements for encrypting the essence (sound, picture and subtitles) of the DCP.
  - **Transport:** Defines the movement from distribution centers to theater locations using physical media, virtual private networks or satellite communications.
  - **Theater Systems:** Provides requirements for all equipment necessary for theatrical presentation in a typical theater environment. This encompasses digital projectors, media blocks, storage systems, sound systems, the DCP files ingest, theater automation, Screen Management System (SMS) and Theater Management Systems (TMS).
  - **Projection:** This section defines the projector and its controlled environment, along with the acceptable tolerances around critical image parameters for Mastering and general Exhibition applications. The goal is to provide a means for achieving consistent and repeatable color image quality. Two levels of tolerances are specified: a tighter tolerance for mastering rooms where critical color judgments are made, and a wider tolerance for satisfactory reproduction in general public exhibition.
  - **Security:** The security chapter provides requirements and fundamental specifications for persistent content protection and controlled access in an open security architecture. These objectives are achieved with high security in a multi-user environment via the application of well respected security and encryption standards in primarily three areas: 1) content encryption, 2) security (key) management and 3) high integrity event logging and reporting.

### 1.3. Document Language

This document consists of normative text and, optional informative text. Normative text is text that describes the elements of the design that are indispensable or contains the conformance language keywords: “*shall*”, “*should*” or “*may*”. Informative text is text that is potentially helpful to the user, but not indispensable and can be removed, changed or added editorially without affecting interoperability. Informative text does not contain any conformance keywords. All text in the document is, by default, normative except: any section titled “Introduction”, any section explicitly labeled as “Informative”, or individual paragraphs that start with the word “Note.” Normative references are those external documents referenced in normative text and are indispensable to the user. Informative, or bibliographic, references are those references made from informative text or are otherwise not indispensable to the user.

The keywords “*shall*” and “*shall not*” indicate requirements that must be strictly followed in order to conform to the document and from which no deviation is permitted.

---

The keywords “*should*” and “*should not*” indicate that among several possibilities one is recommended as particularly suitable, without mentioning or excluding others; or that a certain course of action is preferred but not necessarily required. In the negative form, a certain possibility or course of action is deprecated but not prohibited.

The keywords “*may*” and “*need not*” indicate a course of action permissible within the limits of the document.

*The keyword “reserved” indicates that a condition is not defined and shall have no meaning. However, it may be defined in the future. The keyword “forbidden” is the same as reserved, except that the condition shall never be defined in the future.*

A compliant implementation is one that includes all mandatory provisions (“*shall*”) and, if implemented, all recommended provisions (“*should*”) as described. A compliant implementation need not implement optional provisions (“*may*”).

Requirements are indicated with the key phrases “*is required to*”, “*is encouraged to*” and “*can*” which represent “*shall*,” “*should*” and “*may*” (had the text been in a separate requirements document). This is necessary in order to distinguish requirements from the specification conformance language.

Sentences with the following keywords are italics: *shall, shall not, should not, is required, is not required, is not encouraged* and *is encouraged*.

The names of standards publications and protocols are placed in [bracketed text]. International and industry standards contain provisions, which, through reference in this text, constitute provisions of this specification. *The most recent editions of the referenced standards shall be valid unless otherwise exempted in this specification.* These referenced standards are subject to revision, and parties to agreements based upon this specification are encouraged to investigate the possibility of applying the most recent editions of the referenced standards. Section 10 is a glossary of technical terms and acronyms used throughout this specification. The reader is encouraged to refer to the glossary for any unfamiliar terms and acronyms.

Trademarked names are the property of their respective owners.

Portions of SMPTE standards are incomplete with respect to many behavior requirements, the subjects of which are typically addressed by SMPTE as “Informative” text and informative “Notes.” *Sections of this DCI Specification identify normative requirements that shall take precedence over such SMPTE “Informative” text and informative “Notes.”*

## **1.4. System Objectives**

At the onset of writing a specification for a Digital Cinema system, DCI acknowledged certain fundamental requirements, which are:

- *The Digital Cinema system shall have the capability to present a theatrical experience that is better than what one could achieve now with a traditional 35mm Answer Print.*
- *This system should be based around global standards, or DCI specifications, that are embraced around the world so that content can be distributed and played anywhere in the world as can be done today with a 35mm film print. These standards should be open published industry*

---

*standards that are widely accepted and codified by national and international standards bodies such as: ANSI, SMPTE, and ISO/IEC. To the extent that it is possible, the Digital Cinema system shall emulate theater operations and the theater business model, as it exists today.*

- *The system specification, global standards and formats should be chosen so that the capital equipment and operational costs are reasonable and exploit, as much as possible, the economies of scale associated with equipment and technology in use in other industries.*
- *The hardware and software used in the system should be easily upgraded as advances in technology are made. Upgrades to the format shall be designed in a way so that content may be distributed and compatibly played on both the latest DCI-compliant hardware and software, as well as earlier adopted DCI-compliant equipment installations.*
- *The Digital Cinema system shall provide a reasonable path for upgrading to future technologies. It shall be based upon a component architecture (e.g., Mastering, Compression, Encryption, Transport, Storage, Playback, Projection) that allows for the components to be replaced or upgraded in the future without the replacement of the complete system. It is the intention of this Digital Cinema specification to allow for advances in technology and the economics of technology advancement. It has been recognized that these advances may most likely affect the mastering and projection of Digital Cinema content. Therefore, this document will specify, for example, a resolution and color space that may not be obtained in a present day mastering or projection system. However, it is the intent that the rest of the Digital Cinema system be capable of transporting and processing up to the technical limits of the specification.*
- *This document specifies a baseline for the implementation of a Digital Cinema system. The goal of backwards compatibility in this context is to allow, for example, new content at higher resolution and color space to be played out on a projection system that meets the baseline implementation.*
- *The Digital Cinema system shall also not preclude the capability for alternative content presentations.*
- *The Digital Cinema system shall provide a reliability and availability that is equal to, or better than, current film presentation.*
- *Protection of intellectual property is a critical aspect of the design of the system. This security system should be designed using a single common encryption format along with keys to decrypt the content. The method should provide a means to keep the content encrypted from the time it is encoded in post-production until it is projected on a theater screen. Only trusted entities, deployed in secure environments or implementing physical protection, will be given access to the decrypted content. Content will be decrypted contingent upon usage rules agreed on by content owners, Distributors and Exhibitors. The system should also be renewable in case of a breach of security in any part of the system, and include forensic Marking of the content for providing traceable forensic evidence in the case of a theft of the content.*



---

## 2. SYSTEM OVERVIEW

### 2.1. Functional Framework

For the purpose of documenting the specific requirements and specifications for a Digital Cinema system, it is helpful to divide the system into a set of components<sup>2</sup>, which are:

- Digital Cinema Distribution Master (DCDM) – Contains system requirements regarding the uncompressed, unencrypted file or set of files containing the content and its associated data.
- Compression – Contains system requirements regarding the process that reduces redundancy in source essence data and its inverse, decompression,
- Packaging – Contains system requirements for the process of encryption and decryption of compressed image and audio essence, wrapping and unwrapping of compressed and encrypted files for distribution and playback.
- Transport – Contains requirements related to the distribution of the packaged media.
- Theater System – Contains system requirements for the equipment installed at a theater for control, scheduling, logging and diagnostics.
- Projection – Contains system requirements regarding the performance characteristics used to display the image on the screen.
- Security – Contains system requirements that bear on the protection of content intellectual property rights. Processes for key management, link encryption, Forensic Marking and logging are constituent elements of the security design.

A functional framework of a Digital Cinema encoding and a decoding system are shown below in Figure 1 and Figure 2.

---

<sup>2</sup> The specifications and performance requirements for each of these components will be described in the subsequent sections

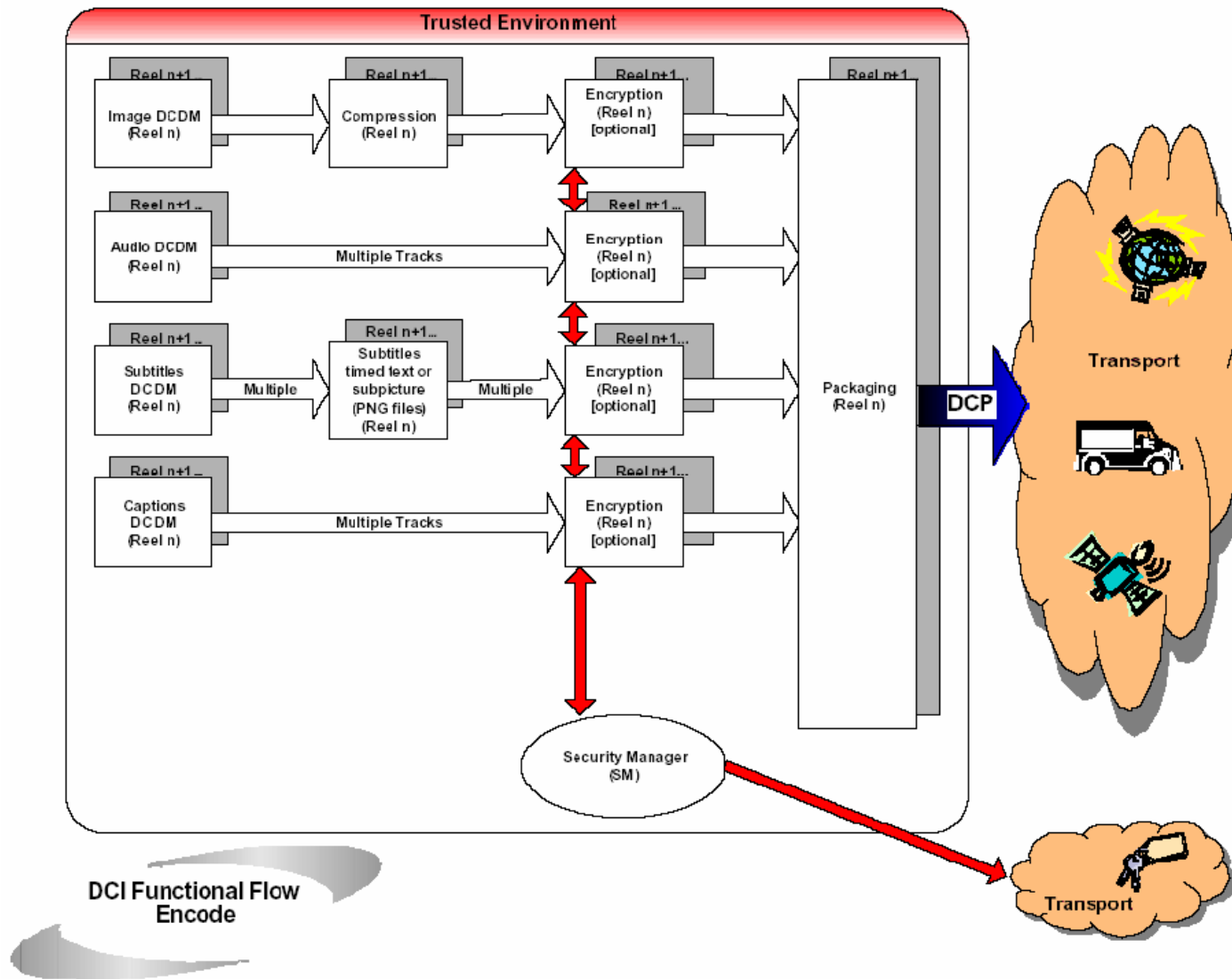

Figure 1: System Overview Functional Encode Flow

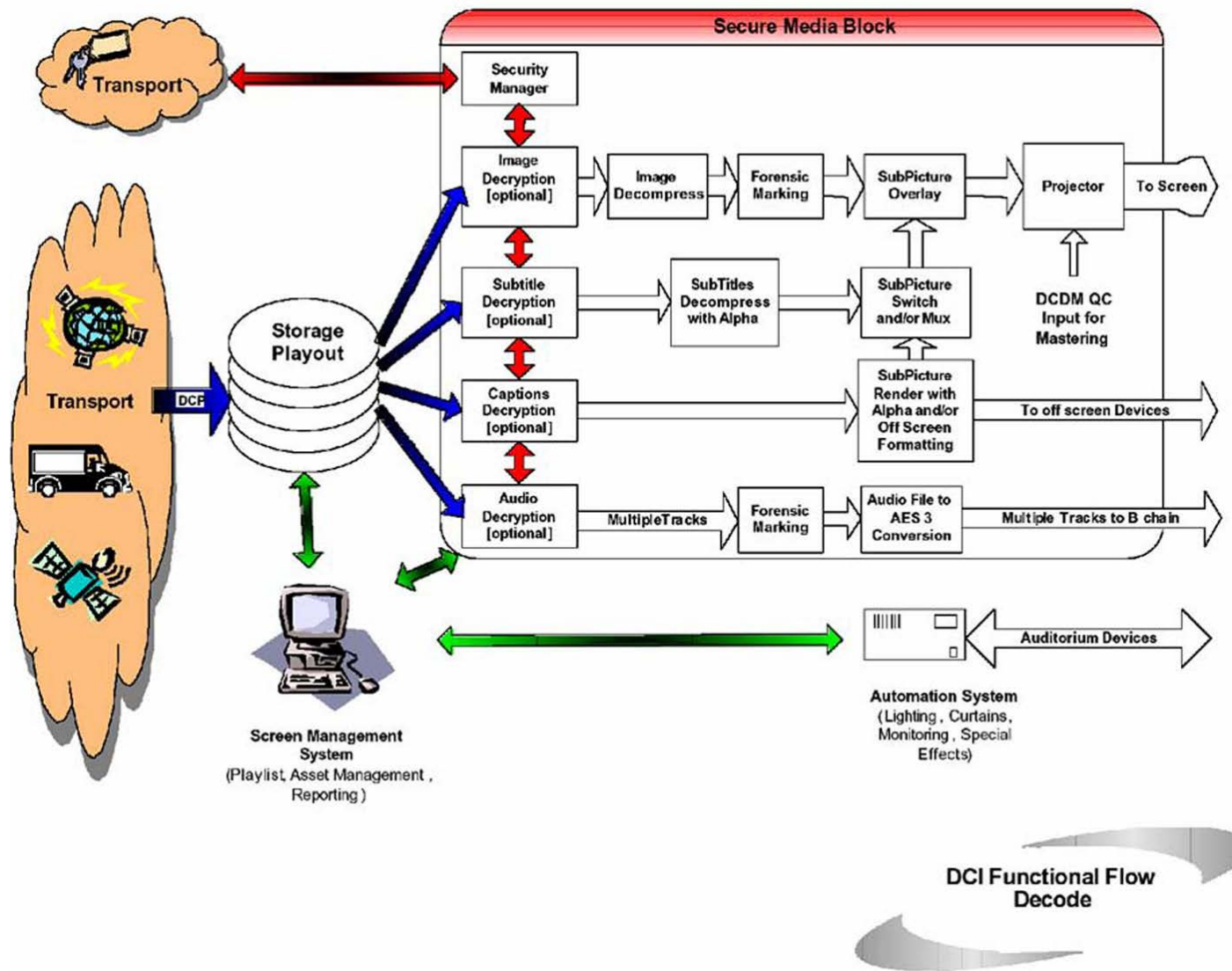

Figure 2: System Overview Functional Decode Flow

---

## 2.1.1. Major System Concepts

### 2.1.1.1. Digital Source Master (DSM)

The Digital Source Master (DSM) is created in post-production and can be used to convert into a Digital Cinema Distribution Master (DCDM). The DSM can also be used to convert to a film duplication master, a home video master, and/or a master for archival purposes. It is not the intention of this document to, in any way, specify the DSM. This is left to the discretion of the content provider. The content could come from a wide range of sources with a wide range of technical levels.

### 2.1.1.2. Composition

When discussing Digital Cinema content, it was realized that other content besides feature films would make use of the same digital system. Therefore, a new term was created to refer to any content that would have similar requirements to feature film content. The term “Composition” refers to all of the essence and metadata required for a single presentation of a feature, or a trailer, or an advertisement, or a logo to create a presentation using a digital system. This term will be used throughout this document and is intended to refer to a single element such as one and only one feature, trailer, advertisement or logo.

### 2.1.1.3. Digital Cinema Distribution Master (DCDM)

This document specifies a DCDM for the purpose of exchanging the image, audio and subtitles to encoding systems and to the Digital Cinema playback system. The DCDM is the output of the Digital Cinema post-production process (not to be confused with the feature post-production process, which creates the DSM) and is the image structure, audio structure, subtitle structure. These structures are mapped into data file formats that make up the DCDM. This master set of files can then be given a quality control check to verify items like synchronization and that the composition is complete. This requires the DCDM files to be played back directly to the final devices (e.g., projector and sound system) in their native decrypted, uncompressed, unpackaged form.

### 2.1.1.4. Digital Cinema Package (DCP)

Once the DCDM is compressed, encrypted and packaged for distribution, it is considered to be the Digital Cinema Package or DCP. This term is used to distinguish the package from the raw collection of files known as the DCDM. Shown below is a typical flow for Digital Cinema. When the DCP arrives at the theater, it is eventually unpackaged, decrypted and decompressed to create the DCDM\*, where DCDM\* image is visually indistinguishable from the original DCDM image.

**DSM → DCDM → DCP → DCDM\* → Image and Sound**

Note: Integrated projector and Media Blocks are strongly recommended. However in the exclusive case to accommodate a 2K, 48 FPS, 12 bit DCDM to use [SMPTE 372M Dual Link HD-

SDI] as an interface, it is acceptable, but not recommended, to allow 10 bit color sub-sampling to create the DCDM\* at the output of the Image Media Block decoder. This bit depth reduction and color subsampling is only allowed in the single combination of a DCDM at 2K, 48 FPS being transported over a link encrypted SMPTE 372M connection.

### 2.1.1.5. Hierarchical Image Structure

The DCDM shall use a hierarchical image structure that supports both 2K and 4K resolution files (See Section 3.2.1 Image Concepts and Requirements so that studios can choose to deliver either 2K or 4K masters and both 2K and 4K projectors can be deployed and supported). The supported mastering and projecting combinations are illustrated in Figure 3: Hierarchical Image Structure Media Blocks (MB) for 2K projectors are required to be able to extract and display the 2K-resolution component from the 2K/4K DCP file(s). Media Blocks for 4K projectors are required to be able to output and display the full 4K DCDM. In the case of a 2K DCDM, the output of the Media Block is a 2K image. It is the responsibility of the 4K projectors to up-sample the image.

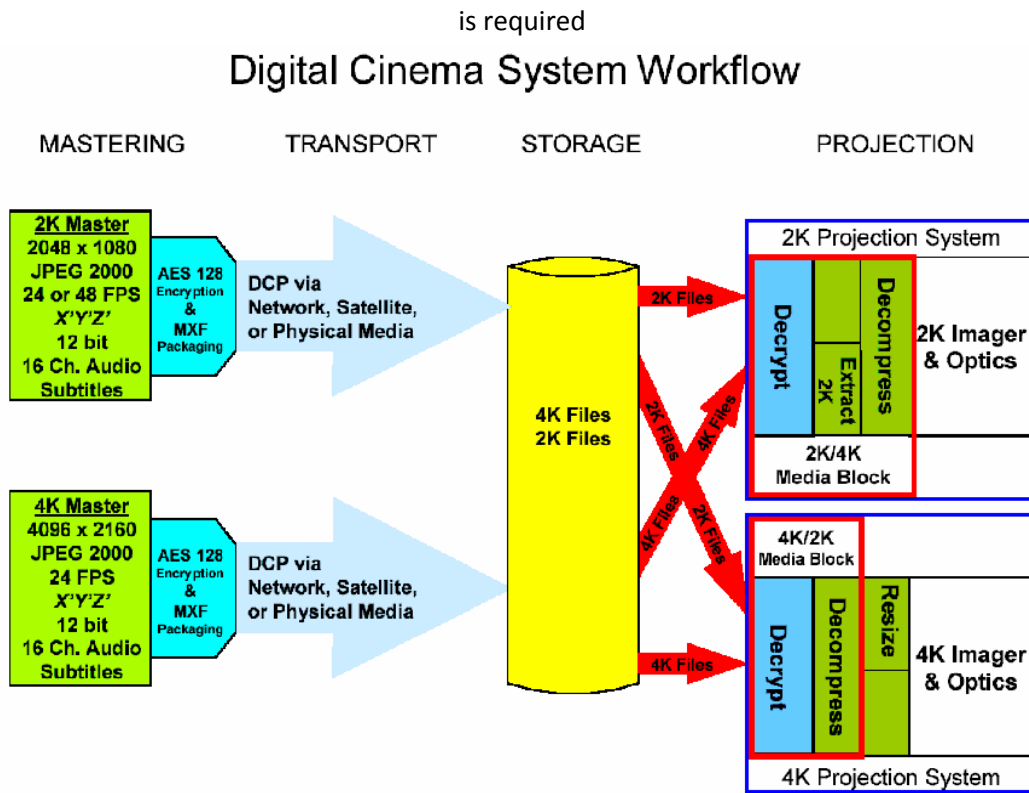

Figure 3: Hierarchical Image Structure

### 2.1.1.6. File / Frame-Based System

This Digital Cinema system is built upon a data file-based design, i.e., all of the content is made up of data stored in files. These files are organized around the image frames. The file is the most basic component of the system.

---

#### **2.1.1.7. Store and Forward**

This Digital Cinema system uses a store-and-forward method for distribution. This allows the files to be managed, processed and transported in non-real time. Non-real time could be interpreted as slower than real time, or faster than real time. After being transported to the theater, the files are stored on a file server until playback. However, during playback and projection, the Digital Cinema content plays out in real time.

#### **2.1.1.8. Reels**

Feature films have been sub-divided for some time into discreet temporal units for film systems called reels. This concept and practice will continue in use for the Digital Cinema system. In Digital Cinema, a reel represents a conceptual period of time having a specific duration chosen by the content provider. Digital Cinema reels can then be electronically spliced together to create a feature presentation.

#### **2.1.1.9. Component Design**

*For the purpose of interoperability, the hardware and software used in the Digital Cinema system shall be easily upgraded as advances in technology are made. Upgrades to the format shall be designed in a way so that content can be distributed and played on the latest hardware and software, as well as earlier DCI-compliant equipment installations.*

*The Digital Cinema system shall provide a reasonable path for upgrading to future technologies. It shall be based upon a component architecture (e.g., Mastering, Compression, Encryption, Transport, Storage, Playback, Projection), that allows for the components to be replaced or upgraded in the future without the replacement of the complete system. It is the intention of this Digital Cinema specification to allow for advances in technology and the economics of technology advancement.*

#### **2.1.1.10. Storage and Media Block**

Storage and Media Block are components of the theater playback system. Storage is the file server that holds the packaged content for eventual playback. The Media Block is the hardware device (or devices) that converts the packaged content into the streaming data that ultimately turns into the pictures and sound in the theater. These two components can be physically contained together or they can be physically separate from each other. Media Blocks are secure entities and the specific nature of that security is defined in Section 9: SECURITY.

---

## 3. DIGITAL CINEMA DISTRIBUTION MASTER

### 3.1. Overview

#### 3.1.1. Introduction

The Digital Cinema Distribution Master, or DCDM, is a collection of data file formats, whose function is to provide an interchange standard for Digital Cinema presentations. It is a representation of images, audio and other information, whose goal is to provide a complete and standardized way to communicate movies (compositions) between studio, post-production and exhibition. A specific instance of a DCDM is derived from a Digital Source Master (DSM) that is created as a result of a post-production assembly of the elements of a movie (composition). A DCDM can be transformed into a Digital Cinema Package for distribution to exhibition sites (see Section 5: PACKAGING). Alternatively, it can be sent directly to a playback system for quality control tasks.

#### 3.1.2. DCDM System Overview

For the purpose of documenting the specific requirements and specifications for the DCDM, it is helpful to divide the system into a set of components. The specifications and requirements for each of these components will be described in the following sections:

- **Image** – The image specification and file format
- **Audio** – The audio specification and file format
- **Subtitles**
  - **Subpicture** – The pre-rendered open text specification and file format
  - **Timed Text** – The Timed Text data specification and file format

#### 3.1.3. Major DCDM Concepts

The Digital Cinema Distribution Master (DCDM) is the fundamental interchange element in the system. Since digital mastering technology will continue to change and develop with time, the DCDM is designed to accommodate growth. There are several areas that will be affected by the progression of the mastering technology, such as color space, resolution, sampling frequencies, quantizing bit depths and interfaces.

In the process of creating feature films, a Digital Source Master, or DSM, is produced. The DSM creates many elements (e.g., Film Distribution Masters, DCDM, Home Video Masters and Broadcast Masters). It is not the goal of this specification to define the DSM. Instead, it is recognized that the DSM can be made of any color space, resolution, sampling frequency, color component bit depths and many other metrics.

If the content does not meet this DCDM specification, it is the content provider's responsibility to convert the DSM into the DCDM specification, defined in this section, before it can be used in the Digital Cinema system.

---

A set of DCDM files (image, audio, subtitles, etc.) contains all of the content required to provide a Digital Cinema presentation. The DCDM provides two functions, an interchange file format, and a playback format that is directly sent from the Media Block to the projector (this is referred to as DCDM\*). For use in interchange, the encoding process can be performed in real time or non-real time. For use in playback, the DCDM\* is logically required to playback in real time.

Metadata within the DCDM provides a method to synchronize image, audio and subtitles. This method is used to synchronize the tracks in order to maintain frame-based lip sync from the beginning to the end of a presentation. This is different from the requirement to synchronize the system clocks of different pieces of equipment to run at consistent frequencies. The first part addresses the packaging of the picture, sound and subtitles in such a way as to establish and maintain a timing relationship between these tracks of essence. The second part addresses the inter-operability of equipment in a theater system and is therefore discussed in Section 7 THEATER SYSTEMS.

### **3.1.4. DCDM Fundamental Requirements**

#### **3.1.4.1. Common File Formats**

*The DCDM is required to use a common standardized file format for each element (image, audio, subtitles, etc.). The DCDM image file format is required to be an MXF-conformant file, based on existing SMPTE standards. The DCDM audio file format is required to be based on Broadcast Wave.*

#### **3.1.4.2. Frame Rates**

*The DCDM image structure is required to support a frame rate of 24.000 Hz. The DCDM image structure can also support a frame rate of 48.000 Hz for 2K image content only. The frame rate of any individual DCDM master is required to remain constant. Metadata is carried in the image data file format to indicate the frame rate.*

#### **3.1.4.3. Synchronization**

*Files within the DCDM set are required to carry information to provide for frame-based synchronization between each file. At a minimum, they are required to include a “start of file” and a continuous frame count.*

## **3.2. Image Specification**

### **3.2.1. Image Concepts and Requirements**

This section defines a common interchange for Digital Cinema uncompressed image structures and files. This includes an image structure, aspect ratios, common color space, bit depth, transfer function, and the file format required to present content properly to a Digital Cinema projector.



---

The SMPTE published standard "SMPTE 428-1: D-Cinema Distribution Master - Image Characteristics" shall be utilized.

**Table 1:** This table left blank intentionally.

**Table 2:** This table left blank intentionally.

**Table 3:** This table left blank intentionally.

## 3.2.2. DCDM Image File Format

### 3.2.2.1. Introduction

The DCDM image file format is mapped into TIFF.

### 3.2.2.2. File Mapping

*The DCDM Image Structure shall be mapped into the TIFF Rev 6.0 File Format and further constrained as follows:*

- *16 bits each per X', Y', and Z' channel, stored in the nominal TIFF R, G and B channels.*
- *The DCDM gamma-encoded X', Y' and Z' color channels are represented by 12-bit unsigned integer code values. These 12 bits are placed into the most significant bits of 16-bit words, with the remaining 4 bits filled with zeroes.*
- *The image orientation shall place the first pixel in the upper left corner of the image.*
- *The DCDM picture file shall contain only the active pixels in the image. In other words, it is not allowed to pad the picture to the full size of the DCDM container.*

### 3.2.2.3. Synchronization

*The DCDM file format is required to contain metadata that allows for synchronization of the images with other content:*

- *Each directory shall contain only one contiguous sequence of frames.*
- *For assembled reels, a separate directory shall be used for each reel with the following naming convention:*
  - *CompositionName.Reel\_#*
- *For inserts, the directory naming convention shall be:*
  - *FeatureName.Reel\_#.Insert\_#*
- *Each reel shall contain sequentially numbered frames, using the following file naming convention. All names when sorted alphabetically shall be in sequential order (leading zeroes required). Therefore, the only thing that changes in the sequence is the frame numbers.*
  - *CompositionName.Reel\_#.FrameNumber.tif*
  - *Example: Stealth.Reel\_1.00001.tif*

#### 3.2.2.4. Image Metadata Required Fields

Image information and parameters, required to successfully interchange the DCDM Image Structure, shall be provided to the mechanism that will ingest the DCDM.

Each frame in the reel shall contain accurate and complete metadata, but it is permissible to read and extract the reel-based metadata from the first frame of a reel to use as a metadata “slate” for the rest of the frames in the reel.

The information, as shown in Table 4 below, is the minimum required information to successfully interchange files.

Data Element Name	Data Element Definition
Active Horizontal Pixels (Ph)	Total number of active horizontal pixels in the image container
Active Vertical Pixels (Pv)	Total number of active vertical pixels in the image container
Frame Rate	The rate that images are to be projected, expressed in frames per second
Frame Count	The integer number of frames in a sequence

Table 4: Required Image Structure Information

### 3.3. Audio Specification

#### 3.3.1. Audio Concepts and Requirements

Digital Cinema audio requires standardized characteristics, channel mapping and a file format to successfully playback in a motion picture theater.

#### 3.3.2. Audio Characteristics

The SMPTE published standard "SMPTE 428-2: D-Cinema Distribution Master - Audio Characteristics" shall be utilized.

#### 3.3.3. Channel Mapping

Channel mapping defines where the individual audio channels are assigned and the labeling of channels in a Digital Cinema audio system. This is done to aid in the identification and the location of channels, thus enabling uniform expression and communication of source audio channels to Digital Cinema playback loudspeakers.

Parameters for 8 channel and 6 channel mapping given in Tables 4.2 and 4.4, respectively, of the SMPTE published standard "SMPTE 428-3: D-Cinema Distribution Master Audio Channel Mapping and Channel Labeling" shall be utilized.

**Table 5:** This table left blank intentionally

**Table 6:** This table left blank intentionally

**Figure 4:** This figure left blank intentionally

---

### 3.3.4. File Format

#### 3.3.4.1. General

*The audio file format shall comply with the Broadcast Wave file format (.wav), per [ITU Tech 3285 version 1 (PCM WAVE coding)], is extended and constrained as further described here.*

*The audio file shall remain uncompressed throughout the Digital Cinema system. This shall include packaging, distribution and storage.*

#### 3.3.4.2. Synchronization

*The Broadcast Wave (.wav) file is required to contain metadata that indicates the first sample of audio data. The metadata is also required to contain a continuous frame count relative to the image as well as the sample rate.*

## 3.4. Text Rendering

### 3.4.1. Text Rendering Concepts and Requirements

Digital Cinema has a subtitling system that can convey multiple languages. Along with subtitling, there are text localizations, titling and captioning that may also be a part of the new Digital Cinema experience. However, captioning and subtitling are identified as two separate systems having different roles in the presentation of content and may have different methods of rendering.

Traditionally, the audience for captioning is the deaf and hard of hearing (D/HOH). The delivery can be done in different ways. These include closed systems that are optional-to-the-viewer delivery and are usually displayed on a personal device (such as a wireless receiver), or delivery to an obscured device that is viewable with an appliance (such as a rear-wall display viewed through a mirror).

Subtitling is generally associated with a foreign language translation for localizing a movie in a particular geographic territory. Subtitles are typically open or displayed on the screen as part of the movie, without option. Subtitling and localizations are generally designed for a particular look with creatively chosen fonts and drop shadows.

With captioning, the source language (what is spoken in the movie) and the target language (what appears as captions) are most often, as in the case of English, the same. For subtitling, the source language and target language are different because the goal of subtitling is to translate the movie.

Subtitles and captions, if supplied, may be one or more of the following:

- *Pre-composited into the Digital Cinema image files (burned-in)*
- *Pre-rendered PNG bitmaps (subpicture), or*
- *Documents containing text and attributes for:*
  - *Rendering in a specified font (Timed Text) and overlaid by the server, an in-line processor or the Digital Cinema projector*
  - *LED displays driven by a captioning processor receiving data from the Digital Cinema server, or*

- 
- *Separate projection systems driven by a captioning processor receiving data from the Digital Cinema server*

Section 3.4.2 Subpicture defines the subpicture specifications, while Section 3.4.3 Timed Text Concepts and Requirements defines the specification for Timed Text streams, which can be used for either subtitles or captions or both. Burned-in subtitles are not addressed since they are something that would occur in the mastering of the content and would be inherent in the image.

## **3.4.2. Subpicture**

### **3.4.2.1. Introduction**

A subpicture data stream is a multiple-image data stream intended for the transport of visual data supplemental to a motion picture. The data is designed for graphic overlay with the main image of a Digital Cinema motion picture. It is designed only for an open display and not for a closed display. It is envisioned that the subpicture data stream, when employed, will typically be used for the transport of subtitle data.

### **3.4.2.2. File Format**

*Subpicture data is required to be encoded as a standardized, XML-based document. Such a standard is required to define both Timed Text and subpicture encoding methods allowing mixed-media rendering. Subpicture frames are required to be encoded as [ISO/IEC 15948:2004] PNG files.*

### **3.4.2.3. Rendering Intent**

*The PNG file is required to be rendered with knowledge of color space and pixel matrix of the DCDM. The PNG file is required to be mastered at the same resolution as the DCDM.*

For example, a DCP containing a 4K master will require 4K PNG files and no other resolution PNG files. When played on a 2K projector, it is the responsibility of the 2K projection system to downsample the 4K PNG files such that they display with the correct size with respect to the image data. And, a DCP containing a 2K master will require 2K PNG files and no other resolution PNG files. When played on a 4K projector, it is the responsibility of the 4K projection system to upsample the 2K PNG files appropriately.

### **3.4.2.4. Frame Rate and Timing**

*The XML navigation file specifies the temporal resolution of the subpicture file. A *Frame count, Time In, Time Out, Fade Up Time and Fade Down Time*, which correspond to the image, shall be included. The subpicture frame rate shall be equal to the frame rate of the associated DCDM image file.*

### **3.4.2.5. Synchronization**

*The equipment or system that encodes or decodes the subpicture file is required to ensure that temporal transitions within the subpicture file are correctly synchronized with other associated*

---

*DCDM files. The Digital Cinema equipment and subpicture file is required to re-synchronize after a restart of the system.*

### **3.4.3. Timed Text Concepts and Requirements**

#### **3.4.3.1. Introduction**

Timed Text (e.g., captions and/or subtitles) is text information that may be presented at definite times during a Digital Cinema presentation.

#### **3.4.3.2. File Format**

*Timed Text data is required to be encoded as a standardized, XML-based document.*

Note: This provides for presentation via:

- Overlay in main or secondary projector image (open), or
- External display (closed)

#### **3.4.3.3. Restart**

*The Digital Cinema equipment and Timed Text file is required to re-synchronize after a restart of the system.*

#### **3.4.3.4. Default Font**

*Font files are required to be used to render Timed Text for subtitle applications. Font files can be used to render Timed Text for caption applications. When used, font files are required to conform to [ISO/IEC 14496-22:2007(E) Information technology - Coding of audio-visual objects - Part 22: Open Font Format]. Timed Text files are required to be accompanied by all font files required for reproduction of the Timed Text.*

*The Timed Text file format is required to support a default character set. It is required that there be a default Unicode™ character set and a default font for that character set.*

*In event that an external font file is missing or damaged, the subtitle rendering device is required to use a default font supplied by the manufacturer. The default character set is required to be a Unicode™ ISO Latin-1 character set. The default font is required to conform to [ISO/IEC 14496-22:2007(E) Information technology - Coding of audio-visual objects - Part 22: Open Font Format] and support the ISO Latin-1 character set.*

#### **3.4.3.5. Identification**

*The Timed Text format requires the cardinal language of the text to be identified.*

#### **3.4.3.6. Searchability**

*A pure text stream is encouraged to isolate content from rendering markup for searchability.*

---

#### **3.4.3.7. Multiple Captions**

*The Timed Text format shall allow the display of multiple captions simultaneously. There shall be a maximum number of 3 lines of text allowed for simultaneous display.*

Note: This allows for spatial representation for captions when two people are talking simultaneously.

#### **3.4.3.8. Synchronization**

*The equipment or system that encodes or decodes the Timed Text file is required to ensure that temporal transitions within the data stream are correctly synchronized with other associated DCDM data streams.*

### **3.4.4. Show Control Concepts and Requirements**

Current day control systems, usually called automation systems, orchestrate theater sub-systems such as curtains, masking and lights. Digital Cinema control methods are expected to differ significantly from those found in theaters today. Supervisory types of control will be much broader in application than in today's systems, allowing interface to specialized controls for theatrical events.

Many of these concepts and requirements are covered in Section 5 PACKAGING and Section:7 THEATER SYSTEMS. Some of the fundamental information pertaining to encoding is covered here, with the detailed information for its use covered in Section 7 THEATER SYSTEMS

### **3.4.5. Show Controls**

#### **3.4.5.1. Introduction**

Many of today's automation controls are driven by a time-based event list such as the system's Show Playlist, and can be classified by their show control functions, as in the partial list below.

- First frame of content
- First frame of intermission
- First frame of end credits
- First frame of end credits on black
- Last frame of content

*Show control events or cues are required for the theater system operator to pre-program the timing of show control events. Such events or cues may indicate events such as the beginning of the title, beginning of the intermission, beginning of the credits, and the end of the feature. The events or cues will normally be placed into the Digital Cinema Composition Playlist, as defined in Section:5 PACKAGING.*

---

## 4. COMPRESSION

### 4.1. Introduction

Image Compression for Digital Cinema uses data reduction techniques to decrease the size of the data for economical delivery and storage. The system uses perceptual coding techniques to achieve an image compression that is visually lossless. It is important to note that image compression is typically used to ensure meeting transmission bandwidth or media storage limitations. This results in image quality being dependent on scene content and delivered bit rate. Digital Cinema image compression is much less dependent upon bandwidth or storage requirements, thereby making bit rate dependent on desired image quality rather than the reverse.

### 4.2. Compression Standard

*The compression standard shall be JPEG 2000 (see [ISO/IEC 15444-1]).*

### 4.3. Decoder Specification

#### 4.3.1. Definitions

- A 2K distribution – the resolution of the DCDM\*<sup>3</sup> container is 2048x1080.
- A 4K distribution – the resolution of the DCDM\*<sup>7</sup> container is 4096x2160.
- A 2K decoder outputs up to 2048x1080 resolution data.
- A 4K decoder outputs up to 4096x2160 resolution data from a 4K compressed file and outputs up to 2048x1080 resolution data from a 2K compressed file.
- *All decoders shall decode both 2K and 4K distributions.* It is the responsibility of the 4K projector to upres the 2K file. In the case of a 2K decoder and a 4K distribution, the 2K decoder need read only that data necessary to decode a 2K output from the 4K distribution. The decoder (be it a 2K decoder or a 4K decoder) need not up-sample a 2K image to a 4K projector or down-sample a 4K image to a 2K projector.

#### 4.3.2. Decoder Requirements

- *Once deployed, the decoder, for any given projector, shall not be required to be upgraded.*
- *The output of the decoder shall conform to Section 3.2 Image Specification.* These images are basically:
  - 4K = 4096x2160 at 24 FPS
  - 2K = 2048x1080 at 24 or 48 FPS

---

<sup>3</sup> The DCP arrives at the theater, it is unpackaged, decrypted and decompressed to create the DCDM\*, where DCDM\* is visually indistinguishable from the original DCDM (where the original DCDM is the input to the Digital Cinema Mastering Process)

- 
- Color: 12 bit, X'Y'Z'
  - *Enhanced parameter choices shall not be allowed in future distribution masters, if they break decodability in a deployed compliant decoder.*
  - *All decoders shall decode each color component at 12 bits per sample with equal color/component bandwidth. Decoders shall not subsample chroma.*
  - *A 4K decoder shall decode all data for every frame in a 4K distribution. A decoder shall not discard data (including resolution levels or quality layers) to keep up with peak decoding rates.*
  - *A 2K decoder shall decode 2K data for every frame in a 4K distribution and it shall decode a 2K distribution. It may discard only the highest resolution level of a 4K distribution. It shall not discard other data such as further resolution levels or quality layers.*
  - *All decoders shall implement the 9/7 inverse wavelet transform with at least 16 bit fixed point precision.*
  - *All decoders shall implement the inverse Irreversible Color Transform (ICT) using at least 16 bit fixed point precision.*

#### **4.4. Codestream Specification**

*All codestreams shall fully conform with [ISO 15444-1:2004/PDAM 1 (soon to be Amendment 1)], as more fully constrained as follows:*

- *The capability parameter for a 2K distribution shall be  $R_{siz} = 3$ , for a 4K distribution it shall be  $R_{siz} = 4$ .*
- *All image frames shall be untiled. More precisely, the entire image shall be encoded as a single tile.*
- *The image and tile origins shall both be at (0, 0).*
- *There shall be no more than 5 wavelet transform levels for 2K content and no more than 6 wavelet transform levels for 4K content. There shall be no less than one wavelet transform level for 4K content. Additionally, every color component of every frame of a distribution shall have the same number of wavelet transform levels.*
- *Codeblocks shall be of size 32x32.*
- *The codeblock coding style shall be  $SP_{cod}$ ,  $SP_{coc} = 0b00000000$ .*
- *All precinct sizes at all resolutions shall be 256x256, except the lowest frequency subband, which shall have a precinct size of 128x128.*
- *There shall be no region of interest, i.e., Region of interest (RGN) marker segments are disallowed.*
- *Coding style Default (COD), Coding style Component (COC), Quantization Default (QCD), and Quantization Component (QCC) marker segments shall appear only in the main header.*
- *Packed Packet headers, Main header (PPM) and Packed Packet headers, Tile-part header (PPT) marker segments are forbidden.*



- The progression order for a 2K distribution shall be Component-Position-Resolution-Layer (CPRL). Progression Order Change (POC) marker segments are forbidden in 2K distributions.
- For a 4K distribution, there shall be exactly one POC marker segment in the main header. Other POC marker segments are forbidden. The POC marker segment shall specify exactly two progressions having the following parameters:
  - First progression:  
 $RSpoc = 0, CSpoc = 0, LYEpoc = L, REpoc = D, CEpoc = 3, Ppoc = 4$
  - Second progression:  
 $RSpoc = D, CSpoc = 0, LYEpoc = L, REpoc = D+1, CEpoc = 3, Ppoc = 4$
  - In the above,  $D$  is the number of wavelet transform levels and  $L$  is the number of quality layers. The constant 3 specifies the number of color components, and the constant 4 specifies CPRL progression.

Note: This POC marker segment ensures that all 2K data precede all 4K data. Within each portion (2K, 4K), all data for color component 0 precede all data for color component 1, which in turn precede all data for color component 2.

- Each compressed frame of a 2K distribution shall have exactly 3 tile parts. Each tile part shall contain all data from one color component.
- Each compressed frame of a 4K distribution shall have exactly 6 tile parts. Each of the first 3 tile parts shall contain all data necessary to decompress one 2K color component. Each of the next 3 tile parts shall contain all additional data necessary to decompress one 4K color component. The resulting compliant codestream structure is diagrammed in Table 7: Codestream Structure. Assuming  $D$  wavelet transform levels ( $D+1$  resolutions), the box labeled 2K<sub>*i*</sub> ( $i = 0, 1, 2$ ) contains all JPEG 2000 packets for color component  $i$ , resolutions 0 through  $D-1$ . The box labeled 4K<sub>*i*</sub> ( $i = 0, 1, 2$ ) contains all JPEG 2000 packets for color component  $i$ , resolution  $D$ .

Main Header	Tile-part Header	2K_0	Tile-part Header	2K_1	Tile-part Header	2K_2	Tile-part Header	4K_0	Tile-part Header	4K_1	Tile-part Header	4K_2
-------------	------------------	------	------------------	------	------------------	------	------------------	------	------------------	------	------------------	------

**Table 7: Codestream Structure**

- *Tile-part Lengths, Main header (TLM) marker segments shall be required in all frames of all distributions.*

Note: This facilitates extraction of color components and resolutions (2K vs. 4K).

- *Distribution masters shall have exactly one quality layer.*
- *For a frame rate of 24 FPS, a 2K distribution shall have a maximum of 1,302,083 bytes per frame (aggregate of all three color components including headers). Additionally, it shall have a maximum of 1,041,666 bytes per color component per frame including all relevant tile-part headers.*
- *For a frame rate of 48 FPS, a 2K distribution shall have a maximum of 651,041 bytes per frame (aggregate of all three color components including headers). Additionally, it shall have a maximum of 520,833 bytes per color component per frame including all relevant tile-part*

---

*headers.*

- *A 4K distribution shall have a maximum of 1,302,083 bytes per frame (aggregate of all three color components including headers). Additionally, the 2K portion of each frame shall satisfy the 24 FPS 2K distribution requirements as stated above.*

Note: For information purposes only, this yields a maximum of 250 Mbits/sec total and a maximum of 200 Mbits/sec for the 2K portion of each color component

---

## 5. PACKAGING

### 5.1. Introduction

The DCDM, as stated in the System Overview, is a collection of files, such as picture essence files and audio essence files. These files, as they stand by themselves, do not represent a complete presentation. Synchronization tools, asset management tools, metadata, content protection and other information are required for a complete presentation to be understood and played back as it was intended. This is especially important when the files become compressed and/or encrypted and are no longer recognizable as image essence or audio essence in this state. Packaging is a way to organize and wrap this material in such a way as to make it suitable for storage and transmission to its destination, where it can be stored and then easily unwrapped for a coherent playback. In seeking a common interchange standard for Digital Cinema between post-production and exhibition, it is understood that there may be multiple sources of content, distributed by more than one distributor, shown in a single show. This will require special consideration to achieve DCP interchange. Thus, an interchange packaging structure is needed that operates across several domains. The section also provides a set of requirements for the Material eXchange Format (MXF) track file encryption. These requirements are complementary to the requirements in Section 9.7 Essence Encryption and Cryptography.

### 5.2. Packaging System Overview

#### 5.2.1. Functional Framework

For the purpose of documenting the specific requirements for a Digital Cinema Packaging system, it is helpful to divide the system into a set of components. The performance requirements for each of these components will be described in the following sections:

- **Composition** – A self-contained representation of a single complete Digital Cinema work, such as a motion picture, or a trailer, or an advertisement, etc.
- **Distribution Package** – The physical files and the list describing the files and providing a means for authentication as delivered in a Distribution Package (from Distributor to Exhibitor).

#### 5.2.2. Packaging Fundamental Requirements

##### 5.2.2.1. Introduction

Digital Cinema presents a challenge to create a versatile packaging system. Throughout this system, some basic requirements are needed and are stated below.

---

#### **5.2.2.2. Open Standard**

*The Packaging standard is required to be based upon an open worldwide standard. This format is encouraged to be a license-free technology. It is required to be a complete standard that equipment receiving a compliant package can process and interpret unambiguously.*

#### **5.2.2.3. Interoperable**

*The Packaging format is required to have an open framework that accommodates compressed, encrypted files as well as all other files used in Digital Cinema.*

#### **5.2.2.4. Scalable**

*The Packaging format is required to accommodate any number of essence or metadata components. There is no limit on the number of files included in the package or the size of the files.*

#### **5.2.2.5. Supports Essential Business Functions**

*The Packaging format is required to support content structure as needed during booking, fulfillment, show preparation, booking updates, secure licensed playback and logging.*

#### **5.2.2.6. Secure**

*The Packaging format is required to support integrity and security at two levels: (1) a basic level which can provide reasonable assurance of file integrity without reference to licenses or a Security Manager (SM), and (2) an engagement-specific level representing a particular business-to-business relationship.*

#### **5.2.2.7. Extensible**

*The Packaging format is required to allow for new Digital Cinema features (compositions) to be contained within the package.*

#### **5.2.2.8. Synchronization**

*The Packaging format is required to provide support for synchronization of the essence and metadata elements.*

#### **5.2.2.9. Human Readable Metadata**

*Human readable metadata is required to be in English (default) but can be provided in other languages as well.*

#### **5.2.2.10. Identity**

*The packaging format is required to support unique and durable identification of assets and metadata using embedded unique identifiers. Throughout this document, the acronym "UUID"*

shall mean a type 4 (pseudo-random) Universally Unique Identifier (UUID) as defined in IETF RFC 4122.

### 5.2.3. Packaging Concepts

It is common practice to divide a feature film into reels of between 10 and 20 minutes in length for post-production, and distribution. These reels are then assembled, together with other content, to create the modern platters that are used in exhibition today. *This concept of reels is required to be supported with Digital Cinema content.*

The Digital Cinema Packaging System is built on a hierarchal structure. The most basic element of the packaging system begins with track files. These are the smallest elements of a package that can be managed or replaced as a distinct asset. A track file can contain essence and/or metadata. Its duration is set to be convenient to the processes and systems that utilize it. These can be image tracks, audio tracks, subtitle tracks or any other essence and/or metadata tracks. A Composition Playlist specifies the sequence of track files that create sequence conceptual reels into a composition. This is illustrated in Figure 5.

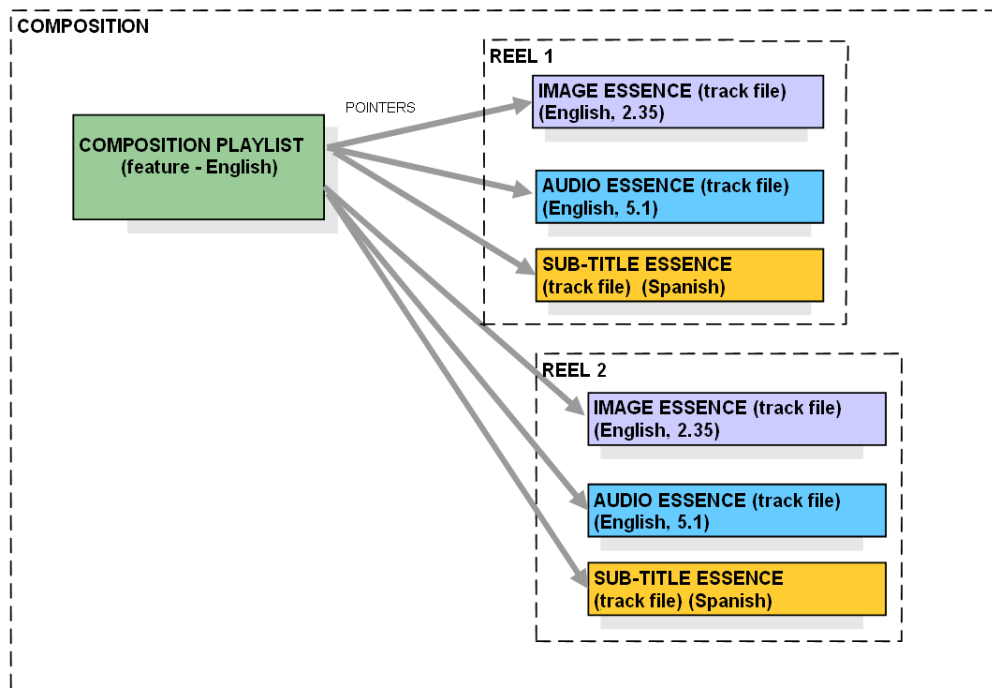
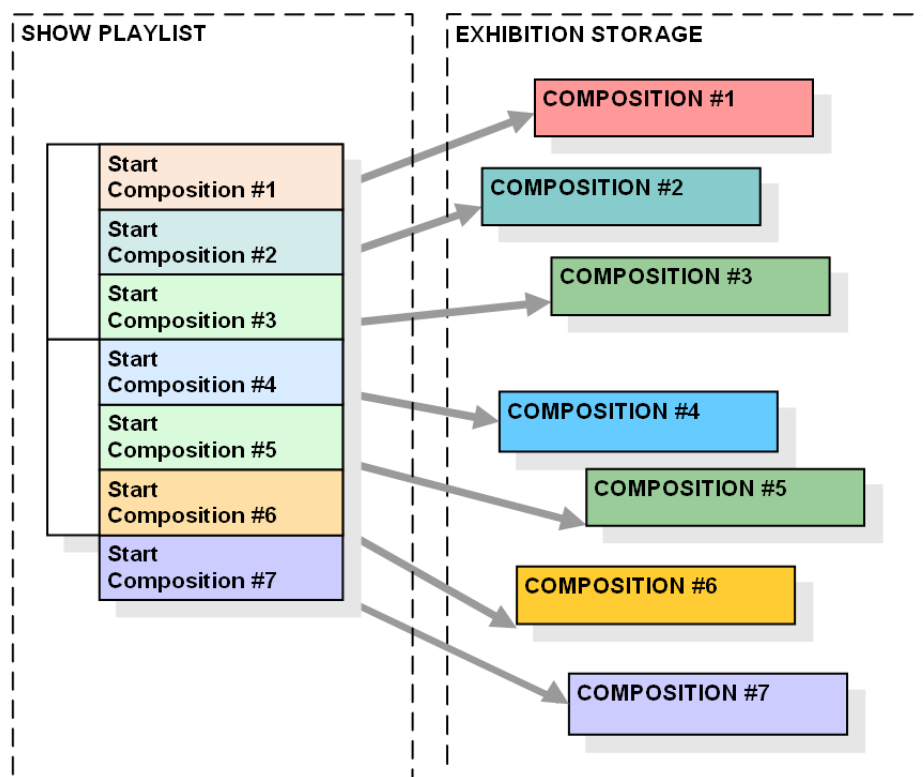

Figure 5: Example Composition Playlist

A Composition Playlist is created in the Digital Cinema mastering process to assemble a complete Composition. This Composition consists of all of the essence and metadata required for a single presentation of a feature, or a trailer, or an advertisement, or a logo. A single Composition Playlist contains all of the information on how the files are to be played, at the time of a presentation, along with the information required to synchronize the track files. A Composition Playlist could consist of one reel or many reels. *For encrypted essence, the Composition Playlist shall be digitally signed such*

that modifications to the Composition Playlist (and/or the associated composition) can be detected. There is a separate Composition Playlist for each version or language audio track of a motion picture/feature (composition). For example, a DCP of a feature film for the European market with French, Italian, German and Spanish audio tracks would contain four separate Composition Playlists, one for each sound track.

At the exhibition site, the Theater Management System (TMS) or Screen Management System (SMS) assembles the Show Playlist. A Show Playlist is created from individual Composition Playlists. The Show Playlist can also be created either on-site or off-site and interchanged as a file to one or more Screen Management Systems. One could have multiple Playlists as well. Figure 6 is an example of a Show Playlist consisting of multiple Composition Playlists.



**Figure 6: Example Show Playlist**

The final element in the Packaging system is a Packing List for the distribution package. The Packing List contains information and identification about each of the individual files that will be delivered in a Digital Cinema Package (DCP). This allows for asset management and validation, including cryptographic integrity checking, for the received DCP. A feature can be sent in a single DCP or multiple DCPs and therefore could be listed in one or more Packing Lists. The Packing List can be sent ahead of the DCP, for asset management purposes. A diagram of a Packing List structure is shown in Figure 7.

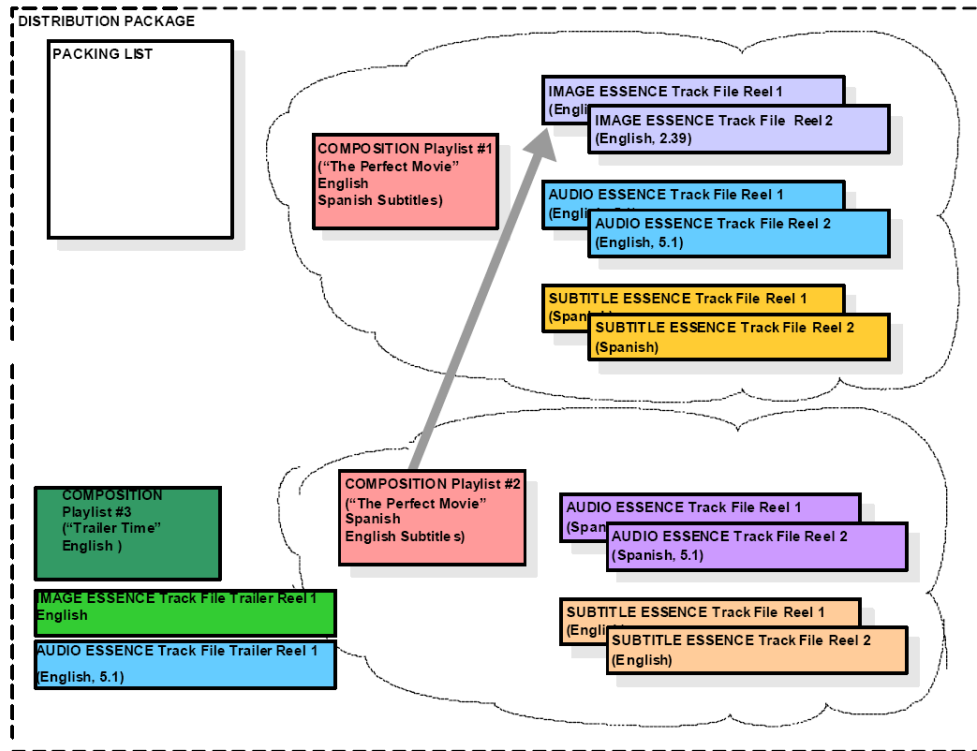

Figure 7: Example Distribution Package

### 5.3. Composition

#### 5.3.1. Track File Concepts and Requirements

##### 5.3.1.1. Introduction

The Sound and Picture Track File is the fundamental element in the Digital Cinema packaging system. The Sound and Picture Track File structure and requirements are defined by the essence or metadata that they contain. Each of these essence or metadata containers could be image, sound, subtitle (Timed Text and/or subpicture) or caption data. However, each track file follows the same basic file structure. A track file consists of three logical parts: the File Header, the File Body and the File Footer as shown in Figure 8.

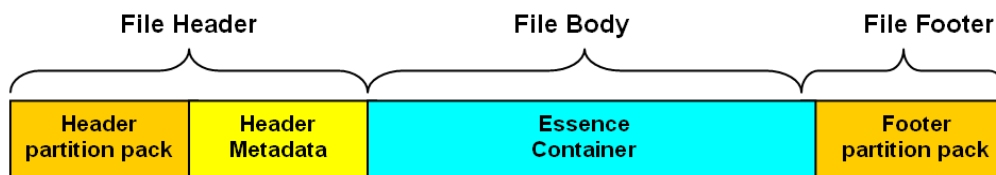
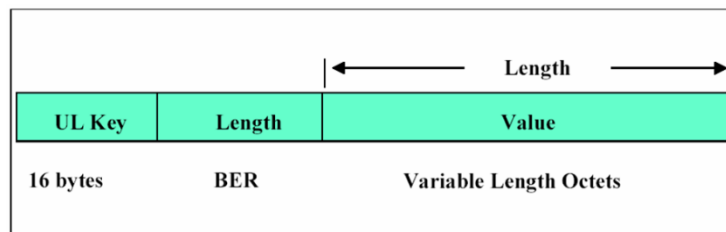

Figure 8: Example Track File Structure

The file structure is further broken down into logical data items as defined in [SMPTE 336M Data Encoding Protocol using Key-Length-Value]. The KLV Coding Protocol is composed of Universal Label (UL) identification Key (UL Key), followed by a numeric Length (Value Length), followed by the data Value as shown below in Figure 9. One or more of these data items are combined to form the logical parts shown above.



**Figure 9: Example of KLV Coding**

#### 5.3.1.2. Format Information

*Each track file is required to be a self-contained element, such that its essence or metadata can be understood and presented as it was packaged by a compliant decoder. The information is required to be located in the predetermined specified area. The Track File is required to contain the following minimum information:*

- Required metadata for unique asset identification
- Required metadata for decompression (optional)
- Required metadata for decryption (optional)

*The following information is required to be configured in a human readable format:*

- Essence physical format description (e.g., 4096 x 2160)
- Essence title asset information (e.g., The\_Perfect\_Movie\_English\_R2)

#### 5.3.1.3. Reel

A Reel is a conceptual period of time having a specific duration, as defined below:

- *Track Files are required to be associated with a particular Reel.*
- *A Track File is required to not cross over a reel boundary that is a playable portion of a track file, between the mark in and mark out points.*
- *Reels are required to be composed of one or more Essence Track Files (e.g., Picture Only, Sound and Picture, Sound and Picture and Subtitle, etc.)*
- *The minimum duration of a Track File is required to be an integer number of frames, such that the length is greater than or equal to one (1) second.*

#### 5.3.1.4. Track File Replacement

A Track File is the smallest unit that can be managed or replaced as a discrete file in the field.



---

#### **5.3.1.5. Synchronization**

*Each Track File is required to contain the following synchronization information:*

- Start of Essence Data (mark in)
- End of Essence Data (mark out)
- Track File Frame Count
- Frame Rate
- Internal Synchronization

#### **5.3.1.6. Splicing**

*Track Files of the same essence type and playback devices are required to support artifact-free splicing at any frame boundary, allowing the assembly of a continuous data stream from multiple Track Files. The playback device is required to perform sample accurate, artifact-free splicing of Sound Track Files, i.e., the playback device must remove any direct current (DC) offset present at the splice point.*

#### **5.3.1.7. Key Epoch**

A Key Epoch is the period of time during which a given Decryption Key is effective. *The Key Epoch shall minimally be one Reel.*

#### **5.3.1.8. Security**

*Each Track File is required to provide for encryption and methods to authenticate the data, if the content provider chooses to use such methods. In addition:*

- *The essence container is required to allow encrypted data, while the rest of the Track File metadata is left unencrypted.*
- *At any point in the delivery chain, it is required to be possible to detect whether any accidental or intentional alteration has occurred.*

#### **5.3.1.9. Integrity and Authentication**

*Each Track File is required to provide a method for verification of file integrity that can be easily determined at any step of the delivery process. In addition:*

- *It is encouraged that missing or corrupted data be easily identified.*
- *Track Files are encouraged to be subdivided into smaller segments, which have individual authenticity/error-check codes. This facilitates a decision as to whether the file is so corrupt it cannot be played, or whether it is safe to proceed with playback while requesting a replacement Track File.*
- *Synchronization with other Track Files is encouraged to be verifiable.*

#### **5.3.1.10. Extensibility**

*The Operational Pattern is required to accommodate future extensions within its original scope.*

---

#### **5.3.1.11. Random Access and Restarts**

*The Operational Pattern is required to support random access to the nearest integer minute. Random access to individual frames is neither required nor desired.*

A restart occurs as a result of a stop or pause in the system while executing a Composition Playlist. *The system may be restarted at any frame prior to the frame at which it was stopped or paused. It is required that a restart be logged by the Security Manager, provided that the essence (either image, audio or subtitle) is encrypted.*

#### **5.3.1.12. Simple Essence**

*A track file is required to contain essence of a single essence type (e.g., audio, image, subtitles). While a Track File can, for instance, contain all audio channels for a given language, additional languages are required to be stored in separate track file. The Composition Playlist will select the correct Track Files to play a requested version of the movie (composition).*

### **5.3.2. MXF Track File Encryption**

#### **5.3.2.1. Introduction**

*MXF Track File Encryption shall be compliant with SMPTE 429-6 D-Cinema Packaging – MXF Track File Essence Encryption. The following requirements clarify the use of SMPTE 429-6 with this specification. For the purpose of this section, a frame is defined as an image frame time, for example 24 FPS or 48 FPS.*

- *Each reel shall use a single cryptographic key for all frames within the sound or picture Track File.*
- *The integrity of each frame of sound and picture essence shall be verifiable using the HMAC-SHA1 algorithm. The optional Message Integrity Code (MIC) element of SMPTE 429-6 shall be present.*
- *There shall be a method for verifying that all frames within a sound and picture track are played in correct sequence. The optional TrackFileID and SequenceNumber elements of SMPTE 429-6 shall be present.*

#### **5.3.2.2. Encrypted Track File Constraints**

*MXF Track File Encryption shall be compliant with SMPTE 429-6 D-Cinema Packaging – MXF Track File Essence Encryption.*

### **5.3.3. Image Track File**

#### **5.3.3.1. Introduction**

An Image Track File contains the image essence data and its associated metadata. Each Image Track File contains compressed image data and, optionally, may be encrypted. The following are requirements for an Image Track File.

---

### **5.3.3.2. Frame Boundaries**

*The Image Track File is required to begin and end with complete frames that allow for splicing. Frames are defined to be image frames such as 24 FPS (1/24 sec) or 48 FPS (1/48 sec). The image data within the Track File shall be wrapped using KLV on an image frame boundary.*

### **5.3.3.3. Compression**

*The Track File is required to support Constant Bit Rate (CBR) compression and Variable Bit Rate (VBR) compression, within the constraints of the specified code stream for the reference decoder (see Section 4 COMPRESSION).*

### **5.3.3.4. Metadata**

*The following metadata is required to be furnished with the Image Track File:*

- Unique ID
- Unique ID of corresponding plaintext track if encrypted
- Track type (i.e., image)
- Active Horizontal Pixels (Ph)
- Active Vertical Pixels (Pv)
- Aspect Ratio
- Frame Rate
- Frame count number (duration)

## **5.3.4. Audio Track File**

### **5.3.4.1. Introduction**

An Audio Track File contains the audio essence data and its associated metadata. The following are requirements for an Audio Track File.

### **5.3.4.2. Frame Boundaries**

*The Audio Track File is required to begin and end with complete frames that are associated with its Image Track File to allow for a clean transition between reels. The audio data within the Track File shall be wrapped using KLV on an image frame boundary.*

### **5.3.4.3. Data Packing Format**

*The Audio Track File is required to support uncompressed audio data.*

### **5.3.4.4. Metadata**

*The following metadata is required to be furnished with the Audio Track File:*

- Unique ID
- Unique ID of corresponding plaintext track encrypted

- 
- *Track type (i.e., audio)*
  - *Audio Sampling Frequency*
  - *Quantization bits (sample size)*
  - *Channel Count*
  - *Channel Mapping Labels*
  - *Data Packing Format*
  - *Frame Rate*
  - *Audio Frame count number (duration)*

### **5.3.5. Subtitle Track File**

#### **5.3.5.1. Introduction**

A Subtitle Track File contains, for example, the Subtitling essence data and its associated metadata. Each Subtitle Track File may contain any combination of text, font references, and image references.

#### **5.3.5.2. Frame Boundaries**

*The Subtitle Track File is required to have the same duration as the playable region of its associated Image Track File.*

#### **5.3.5.3. Timed Text**

*Any Timed Text element is required to use an Open Type font.*

#### **5.3.5.4. Subpicture**

*Subpicture elements are required to use the PNG file format.*

#### **5.3.5.5. Metadata**

*The following metadata is required to be furnished with the subpicture Track File:*

- *Unique identification*
- *Track Type (i.e., Timed Text, subpicture)*
- *Total Width In Pixels of the Image Track File (PNG files only)*
- *Total Height In Pixels of the Image Track File (PNG files only)*
- *Aspect Ratio (PNG files only)*
- *Frame Rate*
- *Position*
- *Timing (Temporal)*

---

### **5.3.6. Auxiliary Track Files and Extensibility**

It may be necessary to package auxiliary data or nonstandard essence for a specific use case. *In these cases the extension shall not interfere with the proper handling of the DCP by an otherwise compliant system.* As a best practice, extensions should adhere to the requirements given in this section and to any extension requirements or guidelines presented in the relevant standards documentation.

## **5.4. Composition Playlists**

### **5.4.1. Introduction**

Composition Playlists (CPL) are textual lists that define how elements of Digital Cinema Compositions are played back in a presentation. The content owner creates the Composition Playlist in a post-production environment. *For encrypted essence, the Composition Playlist shall be digitally signed such that modifications to the Composition Playlist (and/or the associated composition) can be detected.*

### **5.4.2. File Format**

*The Composition Playlist is required to use the secure (digitally signed) text-based XML file format.*

### **5.4.3. Human Readable Information**

*The Composition Playlist is required to contain the following human readable information in English (default) but can be provided in other languages as well.*

#### **5.4.3.1. General Information**

- *A Composition Playlist is required to be identified by ISAN [ISO 15706] or UMID [SMPTE 330M Television – Unique Material Identifier (UMID)].*
- Content Title in human readable text
- Content Kind (e.g., Feature, Trailer, Logo, Advertisement)
- Content Version
- Language
- Country
- Rating
- Aspect Ratio
- Image Format
- Audio Format

#### **5.4.3.2. Image Track Information (list for each reel)**

*Any given Image Track File shall have one or more Entry Points within a given composition playlist.*

- 
- UUID
  - File Authentication Code
  - Entry Point (number of frames offset into the Track File)
  - Duration

#### **5.4.3.3. Audio Track Information (list for each reel)**

*Any given Audio Track File shall have one or more Entry Points within a given composition playlist.*

- UUID
- File Authentication Code
- Entry Point (number of frames offset into the Track File)
- Duration

#### **5.4.3.4. Subtitle Track Information if Present (list for each reel)**

*Any given Subtitle Track File shall have one or more Entry Points within a given composition playlist.*

- UUID
- File Authentication Code
- Entry Point (number of frames offset into the Track File)
- Duration

#### **5.4.3.5. [Removed]**

[This item left blank intentionally.]

#### **5.4.3.6. Digital Signature**

- Encrypted hash (message digest)
- Signer identification

### **5.4.4. Security of the CPL**

*For encrypted essence, the Composition Playlist shall be digitally signed such that modifications to the Composition Playlist (and/or the associated composition) can be detected. In support of this, the CPL assets "KeyID" and "Hash" elements shall be present in the CPL track file asset structure.*

## **5.5. Distribution Package**

### **5.5.1. Introduction**

The Distribution Package has two major components. One is the Package itself, which includes all of the Track Files and the other is the Packing List. These are all of the elements required for a

---

complete delivery to the theater Digital Cinema system. It is technically possible to include engagement-specific licenses and keying information in a Package in the form of opaque metadata, but this is not recommended for general usage.

A Distribution Package can contain a complete feature composition or a set of compositions. Alternatively, it can carry as little as a single file to update one reel's subtitle or sound track.

## **5.5.2. Distribution Package**

### **5.5.2.1. General**

*The Distribution Package is required to contain a Packing List and one or more Digital Cinema Track Files.*

### **5.5.2.2. Packing for Transport**

*The distribution method is required to allow a DCP to be transported via physical media, satellite or network.*

### **5.5.2.3. Security**

*The distribution method is required to provide digital signatures to allow the recipient to verify integrity of the Packing List and the enclosed files. In particular, where the DCP contains encrypted essence files, the Packing List shall be digitally signed.*

Preparation of Packing Lists is a distribution fulfillment or transport function. Therefore, the digital signatures come from these entities, not the content-owner who mastered the files. Packing List security functions do not verify the authenticity of the content, only the intent of the delivery agent. *Content authenticity is verified through signed Composition Playlists and validated Key Delivery Messages.*

## **5.5.3. Packing List**

### **5.5.3.1. File Format**

*The Packing List is required to use XML data format with XML signature (digital signature). It should be in English (default) but can be provided in other languages as well.*

### **5.5.3.2. Fields**

*The following data fields are required to be included in the Packing List for each file in the Package:*

- *UUID*
- *Annotation Text parameter (optional), if present, is a free-form, human readable annotation associated with the asset. It is meant strictly as a displayable guidance for the user.*
- *File Integrity check (hash) for each file in the distribution package*

- 
- *Size of the file in bytes*
  - *Type (e.g., Packing List, Playlist, Track File, opaque security data)*
  - *Original File Name*

*The following fields are required to be included in the digital signature section of the Packing List:*

- *Signer parameter uniquely identifies the entity, and hence public key that digitally signs the Packing List.*
- *Signature parameter contains a digital signature authenticating the Packing List.*



---

## 6. TRANSPORT

### 6.1. Introduction

Transport refers to the movement of the packaged Digital Cinema content. This can be accomplished in many ways, such as physical media, Virtual Private Network (VPN), or satellite. This section will describe any requirements for the transport of packaged content.

### 6.2. Transport System Overview

#### 6.2.1. Transport Fundamental Requirements

##### 6.2.1.1. Introduction

Digital Cinema presents unique opportunities for the transport of theatrical content. Some basic requirements are stated below.

##### 6.2.1.2. Security

*The content owner's encryption is required to not be removed during transport.*

##### 6.2.1.3. Robustness

*The files are required to retain all of the data of the original files upon completion of transport of the Digital Cinema content.*

#### 6.2.2. Transport Fundamental Concepts

The transport of Digital Cinema content can be accomplished in many different ways. The Distributors will select the method that is both economical and technically robust to ship their content to the theaters. This can include the use of physical media or through transmission (e.g., satellite, fiber, copper). *Any selected method is required to provide for a secure environment for the content as well as no corruption of the data.* Segmenting of the packaged content can occur to accommodate fixed media or bandwidth constraints.

#### 6.2.3. Ingest Interface

*Independent of the transport method, the output interface of the transport system is required to be ingested into the Digital Cinema Storage in the theater.*

*The ingest interface shall comply with either Clause 34 or Clause 44 of IEEE 802.3-2005 for either 1000 Mb/s or 10 Gb/s operation, respectively.*

---

THIS PAGE LEFT BLANK INTENTIONALLY

---

## 7. THEATER SYSTEMS

### 7.1. Introduction

Theater Systems for Digital Cinema incorporates all of the equipment required to make a theatrical presentation within an auditorium located within a Theater complex. This encompasses projectors, Media Blocks, Security Managers, storage, sound systems, DCP ingest, theater automation, Screen Management System (SMS) and Theater Management System (TMS). The Screen Management System (SMS) provides the theater manager a user interface for local control of the auditorium such as start, stop, select a Show Playlist and edit a Show Playlist. At a higher level is the Theater Management System (TMS). The TMS can control, supervise and report status on all of the equipment in the Theater as well as perform all the duties of the SMS. This section will define the requirements and interconnectivity of a TMS and multiple SMSs within a theater complex.

### 7.2. Theater System Overview

#### 7.2.1. Functional Framework

For the purpose of documenting the specific requirements and specifications for a Digital Cinema Theater System, it is helpful to divide the system into a set of components. The specifications and performance requirements for each of these components will be described in the following sections:

- **Screen and Theater Management Systems** – The human interface for the Digital Cinema System
- **Theater Systems Architecture** – The equipment and interconnect within the Theater
  - Single Screen Architecture
  - Multiplex Architecture

#### 7.2.2. Theater System Major Concepts

Theater Systems can have a wide range of responsibilities. They are required to provide a theatrical presentation in a timely manner along with controlling the environment in which it is presented. To simplify this complex system, each major component of a Digital Cinema Theater System is reviewed and shown how they interconnect. The human interface of the single screen system is the Screen Management System (SMS). *It is required that there be one SMS for each auditorium.* The Screen Management System (SMS) provides user interface to control (start, stop, pause, load playlist, etc.) a single auditorium. The Theater Management System (TMS) allows a theater manager to control many or all auditoriums within a theater complex from a central location. This is the interface that allows for control, show programming, troubleshooting, asset management and status of the Digital Cinema equipment. There are many different scenarios for the implementation of the SMS and the TMS.

---

### **7.2.3. Theater System Fundamental Requirements**

Digital Cinema Theater Systems have some basic requirements that are stated below.

#### **7.2.3.1. Reliability**

A key part of the Digital Cinema system is reliability. *In the realm of Digital Cinema, the presentation should not be interrupted, except in the event of a catastrophic failure of the Digital Cinema system (e.g., loss of power) or a natural disaster. There will be cases where equipment will fail (such as happens now with traditional 35mm film equipment). However, the time between failures, and the speed at which it is repaired, is encouraged to be no worse than those for traditional 35mm film equipment.*

*Each individual theater system is required to have a Mean Time Between Failure (MTBF) of at least 10,000 hours.*

#### **7.2.3.2. Mean Time to Repair**

*A failed or malfunctioning unit/component is required to be capable of being diagnosed and replaced within 2 hours, exclusive of the time needed to order and to deliver the replacement component(s). Design of a system is required to allow repair of any failed unit/component within two hours.*

#### **7.2.3.3. Test Shows**

*The system is required to allow the content to be played back for validation and verification prior to exhibition.*

#### **7.2.3.4. Monitoring and Diagnostics**

*The system is required to provide monitoring and diagnostic checks and provide for status, monitoring, alignment and calibration. This can be done locally or through remote control.*

#### **7.2.3.5. Easy Assembly of Content**

*The system is required to provide a graphical user interface (GUI) interface for the assembly of content with relative ease in a timely matter.*

#### **7.2.3.6. Movement of Content**

*The system is required to provide for intra-theater movement of content within a multiplex facility. Emergency moves (e.g., equipment failure) between auditoriums are required to allow playback to start within 15 minutes or less after the start of the movement.*

#### **7.2.3.7. Ease of Operation**

*The Digital Cinema Theater System is encouraged to require only a reasonable level of computer operation knowledge or training for the basic operation of the system. The computer-based user interfaces are required to be simple and intuitive.*

---

#### **7.2.3.8. Multiple Systems**

*There can be one Theater Management System communicating to one or more Screen Management Systems.*

#### **7.2.3.9. Environment**

*The theater is required to provide an adequate environment for the equipment, with an operating temperature range of 10-35°C and operating Humidity of 10% to 85% Non-Condensing.*

#### **7.2.3.10. Safety**

*All equipment is required to comply with applicable safety regulations.*

#### **7.2.3.11. Storage Capacity Per Screen**

*The central and/or local storage system is required to have the capacity to hold at least 1 TByte of usable storage per screen, where a TByte equals 1,000,000,000,000 bytes.*

#### **7.2.3.12. Persistent Security**

*Theater systems equipment is required to implement all the security requirements as specified in Section 9 SECURITY. These requirements enable the necessary functions and features for a reliable and persistent environment to protect content and Security Data, and support the required forensic processes that stakeholders require.*

#### **7.2.3.13. Power Failure**

*In the case of a power interruption, the Digital Cinema Theater System is required to be restored into a stable stop/idle condition.*

#### **7.2.3.14. Local Control**

*Every auditorium is required to provide the means of local control by the Screen Management System (SMS) at each projection booth.*

### **7.3. Show Playlist**

#### **7.3.1. Introduction**

The Show Playlist is the list that the Exhibitor assembles to complete a presentation in the theater. The Show Playlist has the following requirements.

#### **7.3.2. File Format**

*The Show Playlist is required to use XML file format.*

---

### **7.3.3. Human Readable Information**

#### **7.3.3.1. General Information**

- UUID
- Program Types (e.g., feature, trailer, logo, advertisement)
- Show Playlist Title
- Version
- Language
- Country
- Rating
- Aspect Ratio
- Image Format
- Audio Format

#### **7.3.3.2. Sequence of Composition Playlists**

- UUID
- Composition and/or Event Playlist Filename
- Show Timeline Count In Point
- Show Timeline Count Out Point

### **7.3.4. Editing Show Playlist**

The Show Playlist is designed to be edited in the field. The requirements for editing are listed below:

- *Shall support adding or deleting of a reference of a Composition Playlist to a Show Playlist*
- *Shall support altering of the sequence of a reference to a Composition Playlist within a Show Playlist*
- *Shall allow for show cue programming and automation*
- *Shall provide programming synchronized to a local clock (timeline)*

## **7.4. Theater Management Systems**

### **7.4.1. Operation**

#### **7.4.1.1. Introduction**

*The Screen Management System (SMS) is required to allow the theater staff to function similar to traditional theater operations.* The workflow does not need to radically change to support Digital Cinema presentations. Digital Cinema content will arrive at the theater via fixed media, or through other means of transport, and will be loaded into central or local storage. The staff will then assemble a Show Playlist using a computer Graphical User Interface. This Show Playlist could include

---

advertisements, logos, previews and a main feature. The staff will then direct the show to the screen and let the SMS begin the show by local or remote control.

The Screen Management System provides a user interface to control (start, stop, pause, load playlist, etc.) a single auditorium. The Theater Management System (TMS) allows a theater manager to control many or all auditoriums within a theater complex from a central location.

At the beginning of this section, fundamental requirements were listed that would allow theaters to operate as they have been for some time. This section will elaborate on some of these and other requirements, as they affect the SMS and TMS.

#### **7.4.1.2. Local Control**

*Each auditorium in a theater complex is required to allow for local control at each screen via the SMS. This will provide for at a minimum:*

- *Show Start*
- *Show Stop*
- *Show Pause*
- *Show Restart*
- *Show programming (single screen installation)*

#### **7.4.1.3. User Accounts**

*The SMS and TMS are required to support multiple levels of user accounts. The following is an example of multiple accounts: Projection, Show Manager, Super-user, and Administrator with password-protected appropriate log-ons.*

**A. Projection – Required to be able to perform the following functions**

- *Browse and activate current shows*
- *Play content, including starting and stopping playback*
- *Assemble shows*

**B. Show Manager – Required to have access to the following functions**

- *All projection functions*
- *Assemble or Delete Shows to/from storage*
- *Import/Delete Content to/from storage*

**C. Super-user – Required to have access to the following functions**

- *All Show Manager functions*
- *User Management*
- *Theater System Setup*

**D. Administrator – Required to have access to the following functions**

- *All Super-user functions*
- *System Setup*

- 
- *Security Setup*

#### **7.4.1.4. Receipt of Content**

*Content can be received by physical media or via a network. The theater systems are required to allow multiple motion pictures and related content to be delivered to a theater in a timely matter. The theater systems are also required to provide a method to verify that the data is complete and whether or not it has not been corrupted.*

#### **7.4.1.5. Movement of Content**

*The SMS and TMS are required to allow an authorized user to search for content and provide a method for the movement and deletion of content, within a screen or multiplex facility, while the system is in operation. As an example, this would include simultaneous content load-in and playback. This movement could consist of many different examples of operation such as:*

- *Downloading content while playback of presentations are in progress*
- *Movement of content from a central storage to local storage while other content is in playback*
- *Deleting content while other content is in playback*
  - I. The SMS or TMS is required to warn and not allow deletion if the content is in use or part of a current Show Playlist.*
  - II. The SMS or TMS is required to provide a deletion process that removes all of the content, key information, and playlists associated with the composition.*

#### **7.4.1.6. Assembly of Content**

*An electronic method is required to assemble trailers, feature presentations and other content in the creation of shows. At a minimum, a standard method is required to electronically identify the content to the SMS, TMS and the Security Manager (SM) to allow the show to be assembled and played back. This method of identification is embedded within the packaging format as metadata. (See Section: 5 PACKAGING)*

*Operationally, the SMS and TMS are required to provide the user with a method of creating a Show Playlist. This method provides for the following:*

- *A method of building shows is required to allow only authorized personal to build, save and transport the Show Playlist.*
- *A method is required to use the validity/expiry method, so that one can check that one has the security devices and keying parameters required for playback.*
- *A method is required to make it possible for a Show Playlist to be provided via an external source.*
- *A method is required to provide a means for inserting a black screen and silence between content. The Media Block is required to be able to transition modes without displaying a roll or similar artifacts during a transition between clips in a playlist or*



---

*between playlists.*

- *Show Playlists can consist of both encrypted and non-encrypted content.*
- *The Show Playlist can be communicated in whole to the Media Block, whereupon it is then stored and subsequently executed within the Media Block (Content Data Pull Model).*
- *The Show Playlist can be executed within the SMS and communicated to the Storage and Media Block one command at a time (Content Data Push Model).*
- *A method is required to provide for the insertion of cues. These cues allow the automation system to perform its tasks at event boundaries, such as start of feature and start of end credits.*

#### **7.4.1.7. Automation Programming**

*The Automation System is required to communicate events to and from the screen equipment. These can be light dimmers, curtains, or other systems within an auditorium. These events or cues are programmed within the TMS or the SMS, and initiated by either the SMS or the Automation depending on which unit is master and which is slave. All of the event types are pre-programmed to have certain effects on the system. These events, at a minimum, are required to be recognized by all systems and are listed below:*

- *First Frame of Content*
- *First Frame of Intermission*
- *Last Frame of Intermission*
- *First Frame of End Credits*
- *First Frame of End Credits on Black*
- *Last Frame of Content*

#### **7.4.1.8. Playback of Content**

*The system is required to provide a method to:*

- *Have full content play functionality (e.g., make playlists active, stop, start, start play) at any reel break point in a playlist.*
- *Handle power interrupted while playing content. When the system is next started, it is required to inform the user that playback was abnormally interrupted during the last play, and offer the user the ability to restart playback at a point prior to the failure (see Section 5.3.1.11 Random Access and Restarts). The system should also log such events.*
- *Have no interruptions during playback (glitch-free).*
- *Adjust the delay of audio  $\pm 5$  image frames in 10 msec increments of all presentation content to the image.*

---

## 7.4.2. Theater Management System Events

The following table depicts situations and events related to the Theater Management System (TMS). These events do not affect the security system and are known only to the Theater Management System. In addition, the Theater Management System has the ability to have pre-showtime knowledge of events in the security system by directing the Screen Management System to query the Security Manager.

Item, Observation or Issue	Approach
Log data collected from auditoriums	TMS controls and can check collection status
Equipment installation and locations	TMS knows about and controls installations
Auditorium scheduling	TMS knows scheduling information

**Table 8: Examples of Theater Management System Events**

The examples in Table 8 are outside of the knowledge or control of the security system. The Theater Management System may have the capacity to execute such functions or make records of various activities under its control. Under a private agreement between the Exhibitor and the Distributor, data collected by the Theater Management System could be made available.

## 7.5. Theater Systems Architectures

### 7.5.1. Introduction

A Digital Cinema Theater System includes several component systems: ingest, storage, Media Block, security, projection, audio system, Theater Management System, Screen Management System and automation. An example of a single screen installation is shown in Figure 10.

### 7.5.2. Ingest

#### 7.5.2.1. Introduction

Ingest is the process of receiving content and security information at the theater level. These are the devices that connect to and from the outside world. The following is an example list of such devices split into two groups. The first group has to do with content while the second group is for security and control.

#### Content:

- Satellite receiver(s) (with cache or local storage)
- Terrestrial fiber network(s) (with cache or local storage)
- Fixed media interface(s)

#### Security and Control:

- 
- Security Management Interface – Standardized Extra-Theater Message (ETM) and logging report communications interface.
  - *Once a complete DCP has been ingested, the TMS or SMS is encouraged to verify that a KDM is available and displays the time window for showing the content. A TMS or SMS show schedule can display conflicts between the KDM and the scheduled showings.*
  - *The TMS or SMS is encouraged to alert the user when a KDM will expire within 48 hours.*

# Single Screen System Architecture

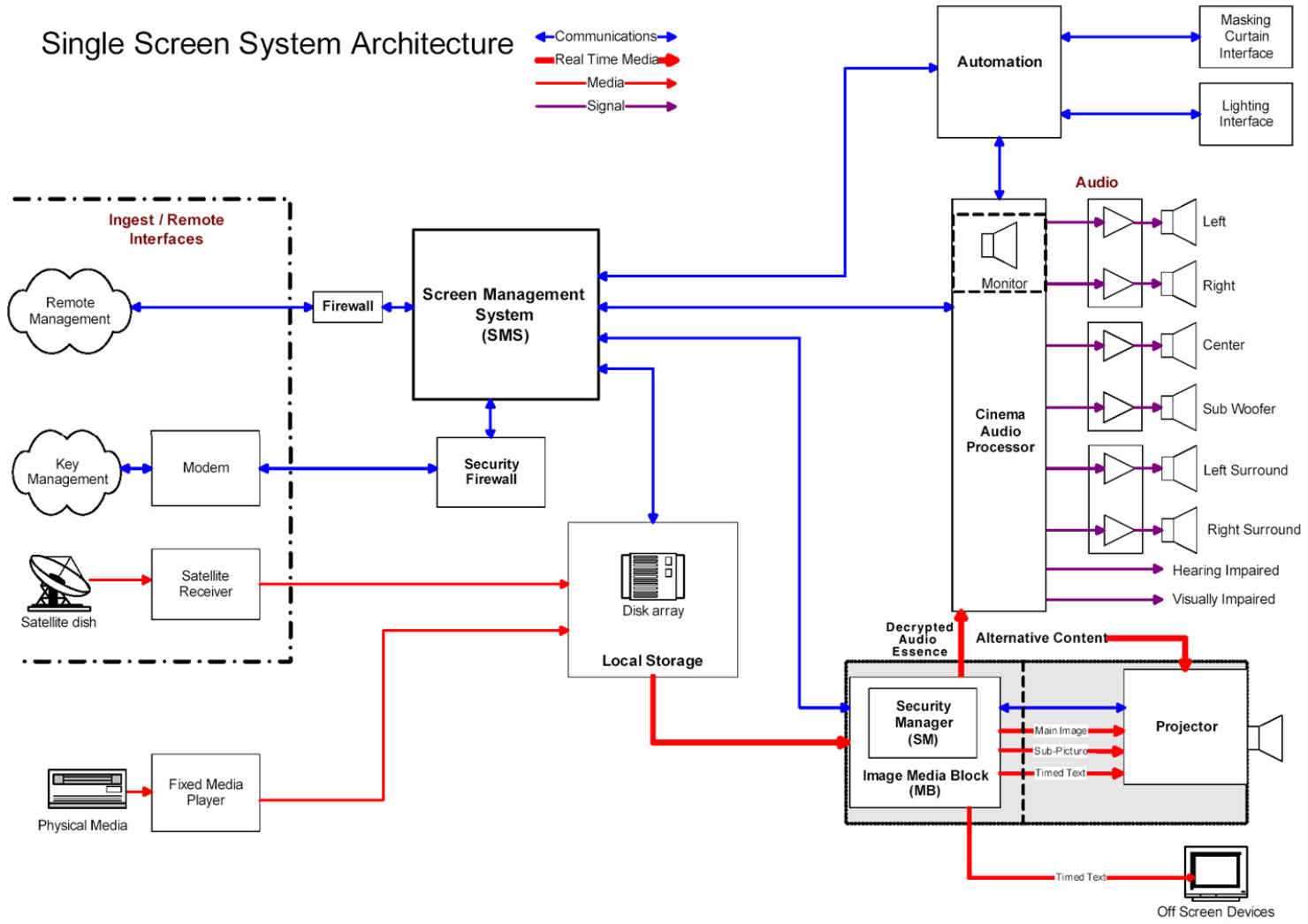

Figure 10: Single-Screen System Architecture

---

### **7.5.2.2. Ingest Interfaces**

Except for security messaging, the interfaces to the outside world can use any method or physical connection. *Inside the theater structure, the architecture is encouraged to break down into two types of interfaces, one for the content and one for control/status and key exchange.*

- *The content ingest interface is required to be Gigabit Ethernet [IEEE802.3ab (copper)] or [IEEE802.3z (fiber)] interface.*
- *Theater facilities are required to provide a connection that will be available 24/7 for security communications (all ETM and log data reporting). It is theater management's decision as to whether this connection is dedicated. However it will be recognized that for some operational situations (e.g., receiving new KDMs), it may be important to have priority access to this connection for security communications. Additional alternative means of security communication can be implemented by agreement between the parties.*

### **7.5.2.3. Firewalls**

*Theater networks are required to protect the security system from the threat of external and internal network-born attacks by the installation of appropriate firewalls.* Because there will be many variations in network designs, it is impossible to define specific solutions as part of this specification. *Exhibition operators are encouraged to solicit competent network security engineering assistance as part of their facility network design efforts.*

See section 9.5.6 (Communications Robustness) for additional exhibition communications and networking requirements.

## **7.5.3. Storage**

### **7.5.3.1. Introduction**

Content storage can be arranged into two basic configurations or a combination of the two. One is known as local storage and the other is central storage. Local storage is a configuration where the storage is located at each screen. Central storage is a configuration that has all of the storage of content in a central location for all of the screens in a multiplex. There can also be combinations of central and local storage.

### **7.5.3.2. Storage Reliability**

The most important aspect of the storage system is reliability. There are a number of RAID configurations that will provide storage redundancy and therefore storage reliability. *The storage system is required to provide redundancy such that should a single hard disc drive fail, the system will continue to play with no visible or audible interruptions or artifacts.*

---

#### **7.5.3.3. Central Storage**

Central Storage implies that packaged content for a multiplex may be stored in one location. Central Storage may allow for multicasting of the content.

*If only Central Storage architecture is used, careful planning is required to be done to ensure that it does not have a single point of failure, including the network. In this type of implementation, the Central Storage is required to also provide the capability to sustain the peak bit rate of all screens being fed simultaneously, along with ingest.*

#### **7.5.3.4. Local Storage**

Local storage implies a single storage system for each screen. *Local storage is required to be able to sustain the bit rate required for the playback of all content for that screen.*

#### **7.5.3.5. Combined Central and Local Storage.**

A combination of central and local storage for a multiplex can be the best solution. The central storage can be used for ingest of material and redundancy of content, while the local storage is encouraged to hold just the content required for the immediate presentation(s).

#### **7.5.3.6. Bandwidth**

*The storage system is required to provide enough output to support a continuous stream of 307 Mbits/sec for compressed image, uncompressed audio (16 channels, 24 bit sample, 96 kHz) and subtitle data to allow for non interrupted Digital Cinema playback.*

#### **7.5.3.7. Capacity**

*Excluding storage necessary for redundancy, the storage system is required to provide for, at a minimum, the storage of three features (including pre-show content) per screen (one feature currently showing and a second or upcoming feature). Shown in Table 9 below, are some example storage requirements. The numbers are based on:*

- One three-hour feature
- 20 minutes of pre-show material at the same resolution
- 16 channels of uncompressed audio at 48 kHz at 24 (AES3) bits
- 3,000 sub pictures in PNG file format
- 3,000 Timed Text lines

Average Bit Rate (Mbits/sec)	3 Hour Image (GBytes)	3 Hou Audio (GBytes)	20 min. pre-show (Gbytes)	Sub Picture (GBytes)	Timed Text (GBytes)	3 Hour Total (GBytes)
250	337.500	2.074	37.500	0.300	0.001	377.374
200	270.000	2.074	30.000	0.300	0.001	302.374
125	168.750	2.074	18.750	0.400	0.001	189.974
100	135.000	2.074	15.000	0.600	0.001	152.674
80	108.000	2.074	12.000	0.800	0.001	122.874

**Table 9: Example of Storage Capacity for one 3-Hour Feature (12 bits @ 24 FPS)**

- Image size:** Calculated by: {Average or max bit rate (Mbits/sec) \* hours \* 60 min/hour \* 60 sec/min} / {8 bits/byte \*1000} the results is in GBytes
- Audio size:** Calculated by: {32 (AES bits) \* 48,000 samples/sec \*16 (channels) \* hours \* 60 min/hour \* 60 sec/min / 8 (bits/byte) = size  
or  
Calculated by: {32 (AES bits) \* 96,000 samples/sec \*16 (channels) \* hours \* 60 min/hour \* 60 sec/min / 8 (bits/byte) = size
- Sub Picture size:** Calculated by: 100,000 (bytes/png file @ level 1) \* 3,000 (subtitles/feature) = size
- Timed Text size:** Calculated by estimate of 1 MBytes per feature

#### **7.5.3.8. Storage Security**

*It is required that image and audio essence on storage devices retains the original AES encryption, if present during ingest. It is required that decrypted plaintext (image or audio) essence is never stored on the storage system.*

### **7.5.4. Media Block**

#### **7.5.4.1. Introduction**

Another key component in the playback chain is the Media Block. One or more Media Blocks are responsible for converting the packaged, compressed and encrypted data into raw image, sound and subtitles.

Depending upon implementation, both security and non-security functions take place within Media Blocks. Security functions of Media Blocks (those functions which process plain text essence or Security Data such as decryption keys) may take place only within physically secure perimeters called Secure Processing Blocks (SPB). The more general functions of the Media Block and variations on implementation are described here. Not all such functions are required to be within an SPB.

Detailed security requirements of Media Blocks are discussed in Section 9.4 Theater Systems Security.

The Media Block can be implemented in a server configuration, as shown in Figure 11. This is where the storage and the Media Block are closely coupled. In this configuration, the content data is then pushed to the final playback device. *In this configuration, Link Encryption is required to protect the uncompressed content.*

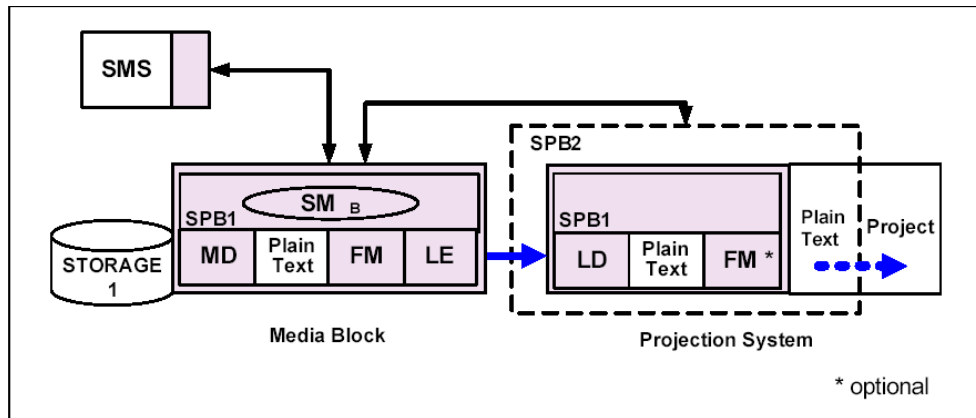

Figure 11: Media Block Server Configuration<sup>4</sup>

The Media Block can also be implemented as a component within the projection system. This provides the option of not requiring Link Encryption. In this configuration, the Media Block may use a push or pull method to process essence data from storage, as shown in Figure 12.

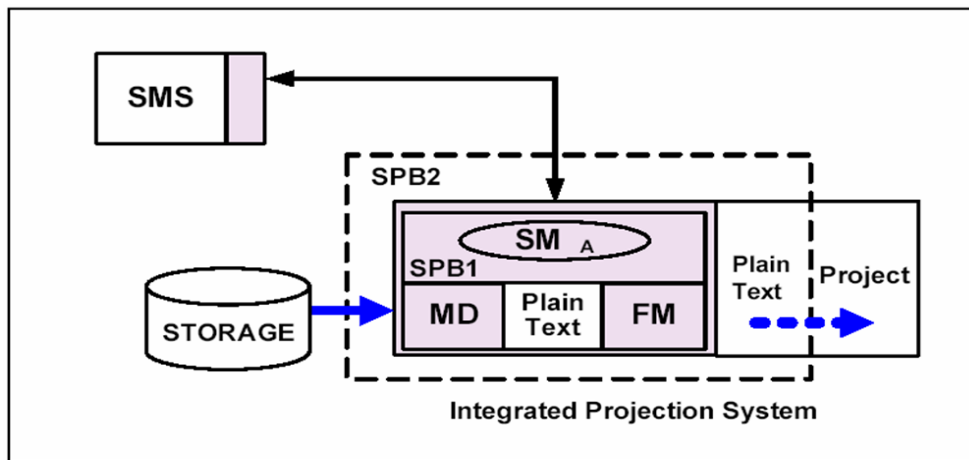

Figure 12: Media Block in Projector Configuration<sup>5</sup>

<sup>4</sup> The double-lined boxes of Figure 11 and Figure 12 show those processing functions required to take place within physically secure SPB type 1 perimeters

<sup>5</sup> The double-lined boxes of Figure 11 and Figure 12 show those processing functions required to take place within physically secure SPB type 1 perimeters



---

Note: Due to the dynamic nature of security technology, DCI reserves the right, at some future time, to update requirements and may require changes to Digital Cinema systems as situations warrant.

#### **7.5.4.2. Media Block Functional Requirements**

##### **7.5.4.2.1. Synchronization**

The Media Block is the device that converts, in real time, the packaged content data from storage into data for playback to downstream devices. *The Media Block is required to playback the image, audio and other timed dependent content in a manner that presents a synchronized performance to the audience.*

##### **7.5.4.2.2. Security Functions**

The main function of the Media Block is to provide a secure environment within which to perform content essence decryption. *In support of this, the Media Block shall contain the Security Manager, image, audio and subtitle processing and the associated forensic markers. Link Encryption shall be applied to image essence if the Media Block is not contained within the projection system.*

*All Media Blocks are required to provide logging functions per the requirements of Section 9.4.6.3.1 Logging Requirements..*

##### **7.5.4.2.3. Image Link Encryption and Decryptor Block**

*If the Image Media Block is not physically located in the same secure container as the projector, then the Image Media Block is required to provide link encryption to the projection system to protect image essence per Section 9.4.4 Link Encryption. At the projector, a Link Decryptor Block is required to decrypt the image essence. The Link Decryptor Block is required to provide SPB type 1 physical protection for link decryption, the associated security keys and logging functions.*

##### **7.5.4.2.4. Unpackaging**

*Any packaged content that comes from storage is required to contain all of the content data required for the presentation and file integrity. The first job of the Media Block is to arrange the track files into their appropriate modules and to provide a timely supply of data to the next process. The content can arrive completely unpacked or partially unpacked depending upon the system's storage method.*

##### **7.5.4.2.5. Alpha Channel Overlay**

*An alpha channel overlay module, to key subtitles or open captions into the Main Image, can be located in the projector or in the Media Block.*

---

#### 7.5.4.2.6. Subpicture Renderer

*The subpicture renderer, a module that converts the subpicture file into the DCDM\* image file with an alpha channel overlay, can be located in the projector or the Media Block.*

#### 7.5.4.2.7. Timed Text Renderer

*The Timed Text renderer, a module that converts Timed Text data into the image file with an alpha channel overlay, can be located in the projector or the Media Block.*

### 7.5.4.3. Media Block Interfaces

*The Media Block is required to interface on three levels with the rest of the system. One level deals with the packaged Digital Cinema content. The next level is the raw essence output for the projector, the audio processor and any special devices for the automation system. The third level is the control and status of the Media Block playback system. These interfaces are noted below.*

- **Packaged Data** – The packaged content requires a standard data interface that could handle bandwidths up to 307 Mbits/sec for the composition data. *This may be a Gigabit or 1000Base-T Ethernet [IEEE 802.3ab (copper)] or [IEEE 802.3z (fiber)] interface.*
- **Uncompressed Essence** – The raw essence data requires a real time data interface with extremely high bandwidths. The interface will depend on the physical location of the Media Block and the type of essence that the interface carries.
  - A. **Main Image** – *This streaming data interface is required to handle data rates up to 10 Gbits/sec. (See Section 8 PROJECTION for details.)*
  - B. **Subpicture** – *This streaming data interface is required to handle data rates up to 20 Mbits/sec. This can be accomplished by the use of a standard 100Base-T Ethernet [IEEE 802.3] interface.*
  - C. **Timed Text** – This could be a streaming data interface depending on the buffer capability of the projector. It is expected that this interface can also use a standard 100Base-T Ethernet [IEEE 802.3] interface that can handle data rates up to 500 Kbits/sec. *It is encouraged that there be at least two of these interfaces from the Media Block, one to feed the projector and the other to feed off-screen devices.*
  - D. **Audio** – *This interface is required to stream multiple digital audio channels to the Cinema Audio Processor. This is required to be in an AES3 format. For worst-case audio bandwidth, 37 Mbits/sec is required (16 channels \* 24 bit sample \* 96 kHz = 37 Mbits/sec).*
- **Security Messaging** – *The Media Block is required to communicate standardized security messages (see Section 9.4.5. Intra-Theater Communications) via a standard 100Base-T Ethernet [IEEE 802.3] interface to the projector and remote Secure Processing Blocks.*

---

This communications facility is referred to as the intra-auditorium security network and it may physically be part of other/existing auditorium networks, which carry other types of traffic (e.g., command, control and status). *However, it is distinguished in that security messaging is required to utilize Transport Layer Security (TLS) at all times.* See Section 9.4.5 Intra-Theater Communications for security messaging requirements.

## **7.5.5. Projection System**

### **7.5.5.1. Introduction**

*The Projection System is required to change digital image data into the light that appears on the screen. The projection system is required to support many interfaces and different Digital Cinema system architectures. One of these architectures includes the Media Block (described above) installed in the projector. In this type of architecture, all of the content is ported through a single data interface. When the Media Block is external to the Projector, Link Encryption is required. The corresponding Link Decryption Block is required at the projector interface.*

Alternative content can come from an external interface, even when the Media Block is present inside the projector.

### **7.5.5.2. Projection System Interfaces**

The Projection System not only provides the main image on the screen, it can provide subtitles, open captioning, and still pictures. This requires extra interfaces from the Media Block, if the Media Block is not installed in the projector. These interfaces are noted below. (For the complete interface specification refer to Section 8 PROJECTION.)

- **Subpicture** – *The subpicture (bit mapped image data with alpha channel) information will need either a separate interface into the projector, or the Media Block is required to overlay the subpicture with the main image and send it through the main image interface. A subpicture interface is required to be a 100Base-T Ethernet [IEEE 802.3] interface with enough sustained bandwidth to support subpictures at up to 24 FPS for 4K content and 24 FPS or 48 FPS for 2K content.*
- **Timed Text** – Information can also enter into the projector through a data port or be rendered and overlaid in the Media Block. *The interface is required to be a 100Base-T Ethernet [IEEE 802.3] interface.*
- **Control and Status** – *The projection system is required to also provide a 100Base-T Ethernet [IEEE 802.3] data interface that can receive control information and send status to the Media Block and SMS.*

---

## 7.5.6. Audio System

### 7.5.6.1. Introduction

The Audio System delivers the sound of the theatrical presentation to the audience. It is responsible for receiving the uncompressed digital audio from the Media Block, converting it to analog and directing it to the proper speakers for translation to acoustic energy. The system is required to provide the capability for 16 channels of audio playback. *The presentation is required to provide, at a minimum, a 5.1 audio format, (Left, Center, Right, Low Frequency Effects, Left Surround and Right Surround).* An audio format of 7.1 can also be provided. The undefined channels can include a Hearing Impaired and/or a Visually Impaired channels as well.

The Cinema Audio Processor can provide the digital audio conversion and the channel mapping. Its other duties can include playing the intermission program or music (often called non-sync) and allowing for monitoring in the projection booth.

### 7.5.6.2. Audio System Interfaces

The Audio System requires several interfaces. The main interface deals with the digital audio and the other interfaces deal with status and control. These interfaces are noted below.

- **Digital Audio** – The digital audio is delivered from the Media Block to the Cinema Audio Processor. This is a real time digital audio link that has the capacity for delivering 16 channels of digital audio at 24-bit 48 kHz or 96 kHz. *This link is required to follow [AES3-2003] recommended practice for serial transmission format for two-channel linearly represented digital audio data.*
- **Control and Status** – *The Cinema Audio Processor is encouraged to also provide a 100Base-T Ethernet [IEEE 802.3] interface that can receive control information and send status to Automation and/or SMS depending on the existing Automation in the theater.*

## 7.5.7. Screen Automation System

### 7.5.7.1. Introduction

A Screen Automation System can interface with life safety, motor controlled curtains, motor controlled masking, the dimmers for the lighting, existing 35mm film projectors and possibly to other devices such as the Cinema Audio Processor, and/or special effects devices. One of the challenges of Digital Cinema is to interface with the many different Automation devices installed presently in the theaters.

### 7.5.7.2. Automation Interface

The automation interface is a variable that is different depending on the manufacturer of the installed system. This could range from contact closures to proprietary interfaces. *The Theater System is required to translate Digital Cinema cues into something that the automation system*

*understands, and reciprocally, is required to translate the automation information into something the SMS understands.*

### **7.5.8. Screen Management System (SMS)**

*Each auditorium is required to have a single dedicated Screen Management System (SMS). The Screen Management System provides a user interface to theater management for local control of the auditorium, such as start, stop, select a Show Playlist and edit a Show Playlist. In addition to control, the Screen Management System can monitor and run diagnostics on equipment within the auditorium and provide such status information to the exhibitor. The Screen Management System is required to operate in one of two modes, local or remote.*

The following table depicts situations and events related to the Screen Management System.

<b>Item, Observation or Issue</b>	<b>Approach</b>
Corrupted Movie Received	SMS can validate received DCP
Valid Composition Playlist Received	SMS can validate received CPL
Movie prepped for playback is modified	SMS can check prepped movie against CPL
Playback time associations of Trailers-Movie	SMS knows show playlists and execution statistics

**Table 10: Examples of Screen Management System Events**

The examples in Table 10 are outside of the knowledge or control of the security system. Under a private agreement between the exhibitor and the distributor, the Screen Management System may be required to execute functions or make records of such activities under its control.

### **7.5.9. Multiplex Theater System Architecture**

#### **7.5.9.1. Introduction**

Many Theater Systems will be part of a larger multi-screen facility. A single TMS for Digital Cinema operations is expected to support all multiplex configurations.

Figure 13: Multiplex Theater System Architecture below demonstrates an example architecture of one of these systems from an interface prospective. This section will consider the requirements and interfaces of a large networked system. There are two main interface components of this larger system. The first is the Media Network and the second is the Theater Management Network.

#### **7.5.9.2. Media Network**

The Media Network is a high bandwidth, switched interface, made up of media interfaces, Disc Arrays and Media Blocks. *The Media Network is required to support sustained rate of 307 Mbits/sec for compressed image (250 Mbits/sec), audio (37.87 Mbits/sec - 16 channels, 24 bit*

---

*sample, 96 KHz) and subtitle data (subpicture 20 MBits/sec) for each screen. Additional data bandwidth is needed for ingesting new content and control/monitoring.*

### **7.5.9.3. Theater Management Network**

#### **7.5.9.3.1. Introduction**

Not all multi-screen complexes will have Theater Management Networks. When present, the Theater Management Network is a low bandwidth, shared interface, made up of Theater System devices and an Ethernet distribution system. *This is required to be accomplished using 100Base-T Ethernet [IEEE 802.3]. This network is required to support all of the control, configuration, security, software upgrades, testing and status of the Theater Systems.*

The Theater Management Network can be sub-divided into two main categories of communications:

- Operational communications – The sending of commands and data to the Theater System devices and receiving status back from those devices. *TCP/IP is required to be the protocol to send commands and configuration. SNMP/UDP/IP (Simple Network Management Protocol over User Datagram Protocol over Internet Protocol) can be used for status of the equipment.*
- Security communications – This messaging supports pre-playback, playback and post playback operations and thus interfaces with the security subsystem(s). *Such communications may take place over the same networks as above. However, security communications are required to employ Transport Layer Security (TLS) per the security requirements of Section 9 SECURITY*

The following is a list of devices and examples of typical communications:

#### **7.5.9.3.2. Screen / Theater Management System (SMS/TMS)**

- **Playback** – Commands and Status, Material IDs, Asset Management
- **Configuration** – Installation Values, Audio Channel Mappings, Automation Behavior, Equipment Behaviors, Equipment Diagnostics
- **Security** – Playability queries, SM Time adjusting, delivery of Key Management messages
- **Software/Firmware Upgrade** – Software Upgrade Mode/Status, Firmware Upgrade Mode/Status messages to Security Managers (SMs), collection of log reports from Security Managers (SMs)
- **Faults** – Equipment ID, Timestamp, Errors
- **Reports** – Equipment Histories, User Logs, Security Events

---

#### 7.5.9.3.3. Storage

- **Playback** – Commands And Status, Material IDs, Asset Management
- **Configuration** – Installation Values, Equipment Behaviors, Equipment Diagnostics
- **Software/Firmware Upgrade** – Software Upgrade Mode/Status, Firmware Upgrade Mode/Status
- **Faults** – Equipment ID, Timestamp, Errors, Disk Error Logs
- **Reports** – Equipment History

#### 7.5.9.3.4. Media Block

- **Playback** – Commands And Status
- **Configuration** – Installation Values, Audio Channel Mappings, Automation Behavior, Equipment Behaviors, Equipment Diagnostics
- **Security** – Contains Exhibition Security Manager performing Authentication, Key Exchange, Key Management
- **Software/Firmware Upgrade** – Software Upgrade Mode/Status, Firmware Upgrade Mode/Status
- **Faults** – Equipment ID, Timestamp, Errors
- **Reports** – Equipment History, Security Events, Playback

#### 7.5.9.3.5. Projection System

- **Playback** – Commands And Status
- **Configuration** – Installation Values, Equipment Behavior, Equipment Diagnostics
- **Security** – Link Encryption Key Exchange with SM, log record delivery to SM
- **Software/Firmware Upgrade** – Software Upgrade Mode/Status, Firmware Upgrade Mode/Status
- **Faults** – Equipment ID, Timestamp, Errors
- **Reports** – Equipment History, Security Events

#### 7.5.9.3.6. Cinema Audio Processor

- **Playback** – Commands And Status
- **Configuration** – Installation Values, Audio Channel Mappings, Equipment Behavior, Equipment Diagnostics
- **Software/Firmware Upgrade** – Software Upgrade Mode/Status, Firmware Upgrade Mode/Status
- **Faults** – Equipment ID, Timestamp, Errors
- **Reports** – Equipment History

# Multiplex Theatre System Architecture

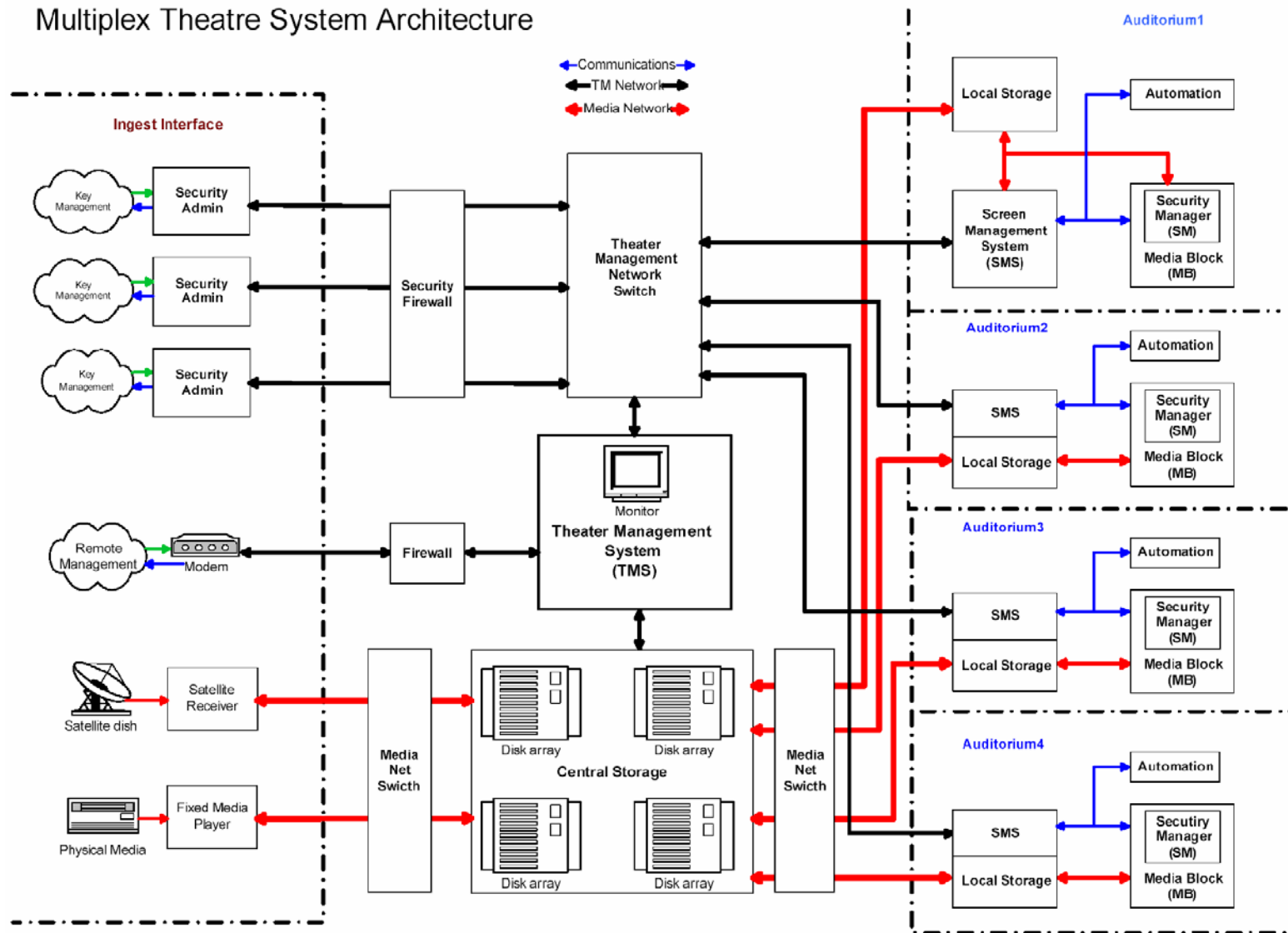

Figure 13: Multiplex Theatre System Architecture



---

## 8. PROJECTION

### 8.1. Introduction

The Projection System is an essential part of the Digital Cinema System. Its job is to change digital image data into light that appears on the screen. This section is broken into parts to help define the requirements, interfaces and performance specifications. Bearing in mind that a core goal is to have the mastering room image seen by the public, it is intended that the projection system should faithfully replicate the DCDM as is described in Section 3 DIGITAL CINEMA DISTRIBUTION MASTER.

### 8.2. Projection System Overview

#### 8.2.1. Functional Framework

For the purpose of documenting the specific requirements and standards for a Digital Cinema Projection system, it is helpful to divide the system into a set of components. The specifications and performance requirements for each of these components will be described in the following sections:

- **Colorimetry** – The method for color conversion (see Section 3.2.1 Image Concepts and Requirements)
- **Performance Parameters** – Performance specifications and requirements
- **Interfaces** – The physical connections to and from the projector (see Section 8.4 Projector Interfaces)

#### 8.2.2. Projection Fundamental Requirements

##### 8.2.2.1. Introduction

Digital Cinema presents a challenge to create a versatile projection system. Throughout this system, some basic requirements are needed and are stated below.

##### 8.2.2.2. Interfaces

*The projector is required to have the following interfaces:*

- *For control and status, 100Base-T Ethernet [IEEE 802.3] interface.*

The projector can have:

- Graphics and/or Text Interface (could be the same as Control and Diagnostics, e.g., Ethernet Interface)

*The projector is required to have either an:*

- *Uncompressed image interface (with Link Encryption), or a*
- *Media Block Interface (if the Media Block is installed in the projector)*

*The projector is required to not have any test, utility or output interface that provides unencrypted content in the clear.*

---

#### **8.2.2.3. Alternative Content**

*The projector is required to not preclude the ability to present alternative content. The projector can also provide an auxiliary content input.*

#### **8.2.2.4. Single Lens**

*The projection system is required to provide either a single lens solution or an unattended changeover if more than one lens is required.*

#### **8.2.2.5. Color Space Conversion**

*The projection system is required to convert the incoming DCDM\* color space to its native color space.*

#### **8.2.2.6. Pixel Count**

*The sampling structure of the displayed picture array (pixel count of the projector) is required to be equal to or greater than that of the specified image containers (either 4096 x 2160 or 2048 x 1080).*

#### **8.2.2.7. Spatial Resolution Conversion**

*The projector is required to display either a native resolution of 4096x2160 or 2048x1080. If the projector's native resolution is 4096x2160, and the incoming spatial resolution of the content is 2048x1080, then the projection system is required to perform the up-conversion of 2048x1080 content to 4096x2160. All spatial conversions are required to be done at an exact ratio of 2:1 in each axis, i.e., a projector with a horizontal pixel count of slightly higher than the image container is required to not convert the projected image beyond the image container to fill the array, nor is an image to be converted to something less than the 4096x2160 or 2048x1080 image container size.*

*Should electronic image resizing or scaling be used to support a constant height projection or constant width projection theater environment, then it is required that the image resizing or scaling does not introduce visible image artifacts. It is intended that the projector project the full horizontal pixel count or the full vertical pixel count of the image container.*

#### **8.2.2.8. Refresh Rate**

*If the incoming frame rate is not the projection system native refresh rate, then the projector is required to convert it to its native refresh rate.*

#### **8.2.2.9. Forensic Marking**

*A Forensic Mark is required to be inserted in real time into the content at the earliest point after decryption and prior to the content data being present on any data bus outside the Media Block (see Section 9.4.6.1 Forensic Marking).*

---

#### 8.2.2.10. Media Block

*In the preferred implementation, the projector is required to provide an area for a Media Block to be installed. If the Media Block is installed external to the projector, then a link encrypted interface is required to ensure that no Digital Cinema content is in the clear.*

### 8.2.3. Projection Concepts

The Digital Cinema projector is one of the principal elements in the system. It is perceived that projector technology will continue to change and develop with time. There are several items affecting the projection system: color space, resolution, brightness, contrast and interfaces. *The projector is required to convert from the incoming X'Y'Z' color space to its native color space. The projector is required to support more than one spatial resolution and frame rate.*

A Reference Projector is used in the mastering process for creating the Digital Cinema Distribution Master (DCDM), with the target performance parameters and tolerances included in this chapter described below. Test patterns and measurement procedures are defined for measuring these performance parameters. It also describes a controlled environment for the mastering of projected images. The goal is to provide a means for achieving consistent and repeatable color quality.

## 8.3. Projected Image and Viewing Environment for Digital Cinema Content

### 8.3.1. Introduction

This section provides requirements defining the reference input to a Digital Cinema projector, the viewing environment, and output display characteristics for mastering and theatrical environments. These requirements are provided to ensure a single inventory distribution will be input compatible with any brand projector and that the projector output will be predictable, based on the standard format input. Nominal reference points plus tolerances are provided.

### 8.3.2. Input

*The projector is required to support the image structures, aspect ratios, file formats, and frame rates as specified in Section: 3.2 Image Specification. The projector can support other image structures, aspect ratios, file formats, and frame rates as determined by the individual manufacturer.*

### 8.3.3. Environment, Image Parameters and Projected Image Tolerances

*The SMPTE published recommended practice "SMPTE RP 431-2: D-Cinema Quality - Reference Projector and Environment" shall be utilized and shall be normative in its entirety for this specification.*

**Table 11:** This table left blank intentionally.

**Table 12:** This table left blank intentionally.

**Table 13:** This table left blank intentionally.

**Table 14:** This table left blank intentionally.

---

## 8.4. Projector Interfaces

### 8.4.1. Introduction

Projection systems will likely have many input/output interfaces to support the various signals that are required to send and receive data between projector, Media Block (MB) and Screen Management System (SMS). Any security aspect of the use of these interfaces is described under Section 9 SECURITY.

### 8.4.2. Media Block Interface

The preferred implementation of a Digital Cinema system would locate the Media Block in the projector. *At a minimum, the Media Block is required to decrypt, decompress and forensically mark the image and provide this to the internal projector interface. The Security Manager is required to be notified in the event of tampering or removal of any Media Block. If the Media Block is external to the projector, then a secure interface, utilizing Link Encryption, is required between the Media Block and the projector.*

### 8.4.3. Uncompressed Image Interface

#### 8.4.3.1. Introduction

*For the mastering environments, an uncompressed image interface is required. Since mastering environments are considered trusted environments, it is not required that these interfaces support link encryption.*

For theatrical environments, the preferred solution is for the Media Block to be located inside the projector. *The Forensic Mark is required to be inserted at the point of the internal interface between the Media Block and the projector. In the case where the Media Block is external to the projector, it is required that the projector uncompressed interface provide a robust Link Decryption. In this case, the Forensic Mark is required to be inserted within the Media Block at the output of decoding and prior to Link Encryption (See Section 9.4.4 Link Encryption).*

#### 8.4.3.2. Dual-Dual (Quad) Link HD-SDI

For mastering environments, the interface can be a dual-Dual Link HD-SDI [SMPTE 372M Link 1.5 Gb/s Digital Interface for 1920x1080 and 2048x1080 Picture Formats].

*When used in theatrical environments, it is required that the dual-Dual Link HD-SDI [SMPTE 372M Link 1.5 Gb/s Digital Interface for 1920x1080 and 2048x1080 Picture Formats] be encrypted. The encryption specification is required to be an open international standard. The encryption is required to use AES with a 128-bit key. (See Section 9.4.4 Link Encryption)*

Note: dual-Dual Link HD-SDI is to accommodate 2K 48 FPS, 12-bit.

---

#### **8.4.3.3. Dual Link HD-SDI**

The interface can be Dual Link HD-SDI [SMPTE 372M Link 1.5 Gb/s Digital Interface for 1920x1080 and 2048x1080 Picture Formats]. *However, this interface is only compliant if provisions are made for 2K 48 FPS support (see Section 2.1.1.4 Digital Cinema Package (DCP)).*

*When used in theatrical environments, it is required that the Dual Link HD-SDI be encrypted. The encryption specification is required to be an open international standard. The encryption is required to use AES with a 128 bit key. (See Section 9.4.4 Link Encryption)*

#### **8.4.3.4. 10 Gigabit Fiber**

For mastering environments, 10 Gigabit fiber, also known as [IEEE 802.3ae], may be adapted for a point-to-point interface. The goal for this interface would be to use the same physical layer and adopt a protocol for streaming image data. Listed below are some of the requirements:

- *Dual SC Fiber Connector (back haul status/handshake)*
- *Multi Mode*
- *Point-to-point*
- *Matrix Switch and/or Patchable*
- *Up to 100 meter runs*
- *Physical Interface established (Layer 1)*
- *Electrical Interface established (Layer 1)*
- *10 Gbit/sec link bandwidth to accommodate up to DCDM in real-time*

#### **8.4.4. Graphics and Timed Text Interface**

Timed Text and subpicture interfaces are required to use a 100Base-T Ethernet [IEEE 802.3] interface. This may be the same interface that is used for control and status.

#### **8.4.5. Control and Status Interface**

These signals allow the SMS, TMS, the projector and the theater automation system to communicate. *The physical implementation is required to be 100Base-T Ethernet [IEEE 802.3]. The protocol used is required to be the same as the Theater Management Network. (See Section 7 THEATER SYSTEMS)*

##### **8.4.5.1. Control**

The following is an example list of control messages that can be sent to the projector:

- Local / Remote
- Power On / Off
- Douser On / Off
- Input Select
- Test Signal On / Off

- 
- Test Signal Selection
  - User Memory Recall 1 to n
  - Zoom In / Out
  - Focus + / -
  - Lens Shift Up / Down
  - Lamp Mode Full, Half
  - Lamp Hours Reset
  - Keystone + / -

#### **8.4.5.2. Status**

The following is an example list of status messages that can be sent from the projector:

- Projector On / Off
- Projector Standby Mode
- Projector Cool Down Mode
- Douser On / Off
- Lamp off due to Power Management
- Temperature Readings
- Temperature Warning
- Temperature Sensor Failure
- Temperature Shut down
- Current Input selection
- Input Signal Status
- Test Signal On / Off
- Test Signal Selection
- Lamp Hours Total
- Lamp Hours Bulb Life
- Lamp Mode
- Image Format – Aspect Ratio
- Power Failure

---

## 9. SECURITY

### 9.1. Introduction

This section defines the requirements for Digital Cinema security. Though security is an end-to-end process, these specifications are focused on the exhibition environment. *The high level business requirements for security are:*

- *Enable the decryption and playback of feature films, based upon business rules agreed upon by Exhibition and Distribution.*
- *Provide persistent security protection against unauthorized access, copying, editing, or playback of feature films.*
- *Provide records of security-related events.*

*The high level technical requirements for security are:*

- *Meet the above business requirements.*
- *Define an open security architecture.*
- *Provide a minimum set of standards around which the exhibition security infrastructure can be implemented by multiple equipment suppliers.*

Security is provided primarily through the application of encryption technology and the management of content key access. When content is transported and received in an encrypted fashion, it is necessary to establish standardized methods of delivering and utilizing decryption keys to unlock the content. This is known as key management. Associated with key exchange is DRM (Digital Rights Management), which establishes the rules for using content. The management of DRM is known as security management. *DRM requirements include logging of content access and other security event information.*

In the security architecture defined herein, security management functions are entrusted to a Security Manager (SM), a logically separable and functionally unique component of the architecture. The security system is referred to as the infrastructure that provides security features, and the Security Manager is at the heart of this infrastructure. *At exhibition, each Digital Cinema auditorium shall have its own dedicated security system, which is comprised of multiple subsystems under the supervision of the Security Manager.* The security system architecture is defined to provide open and standardized security operation and enable interoperability between an exhibition SM and the rest of the exhibition security infrastructure.

Section 9 SECURITY is organized as follows:

- **Fundamental Security Requirements** (Section 9.2)– System-level goals, which security implementations are required to meet.
- **Security Architecture Overview** (Section 9.3)– Definitions and description of the basic security architecture, security messaging, and role of the Security Manager.
- **Theater Systems Security** (Section 9.4)– Security and equipment functions, behavior requirements and security operations at exhibition.

- **Implementation Requirements** (Section 9.5)– Requirements for equipment implementation, physical and logical robustness and certification.
- **Security Features and Trust Management** (Section 9.6) – The requirements and implementation of security policy and trust infrastructures.
- **Essence Encryption and Cryptography** (Section 9.7)– Cryptographic requirements for essence encryption and related cryptography.
- **Digital Certificates, Extra-Theater Message and Key Delivery Message Requirements** (Section 9.8.) – Detailed requirements for Digital Certificates, Extra-Theater Message and Key Delivery Message.

The following acronyms are introduced and used extensively in Section 9

SM	Security Manager
KDM	Key Delivery Message
ETM	Extra-Theater Message
ITM	Intra-Theater Message
TDL	Trusted Device List
FM	Forensic Marking (Marker)
SE	Security Entity
SPB	Secure Processing Block
RRP	Request-Response Pairs

## 9.2. Fundamental Security System Requirements

This section describes the goals for the security system. Cryptographic security requires communications connectivity between Distribution and Exhibition, above what is required for 35mm film. However, at no time do security requirements mandate continuous on-line connectivity to an exhibition facility.

Note: Due to the dynamic nature of security technology, DCI reserves the right, at some future time, to update requirements and may require changes to Digital Cinema systems as situations warrant.

### 9.2.1. Content Protection and Piracy Prevention

*The security system shall provide a means for the securing of content against unauthorized access, copying, editing, and playback. Protection shall be standardized primarily through the application of encryption technology, management of content key access and robust logging.*

### 9.2.2. Single Inventory and Interoperability

*The security system shall support a single inventory Digital Cinema Package (DCP) delivered to every compliant theater installation. The security system architecture shall support file interoperability for both the Digital Cinema Package (DCP) and the Key Delivery Message (KDM). The security system architecture shall require system interoperability between Security Manager (SM) and Screen Management System (SMS).*



---

### 9.2.3. Reliability

*The security system shall recognize that “the show must go on” except in extreme circumstances. The model shall support intelligent means to locate failures expeditiously, and support field replaceable security devices.*

### 9.2.4. Support Forensics and Attack Detection

- *The security system shall produce records of the access to secured content at authorized facilities.*
- *The security system shall support techniques to expose security attacks in process prior to an actual loss.*
- *The security system shall support techniques (e.g., Forensic Marking) to implant evidence of origin of the content for use in tracing unauthorized copies of the content to the source.*
- *The security system shall support the interface(s) and operation of anti-camcorder devices. This may include, but is not limited to, the ability to log the results of an anti-camcorder (detection of a camcorder event) or a non-functional anti-camcorder-ing system.*

### 9.2.5. Resist Threats

*The security system shall support prevention and detection of the following threats:*

- *Content theft (piracy) – as noted above*
- *Unauthorized exhibition (e.g., at wrong facility)*
- *Manipulation of content (e.g., editing)*
- *Un-logged usage of content*
- *Denial of Service*

## 9.3. Security Architecture Overview

This section describes the architectural elements and fundamental operation of the Digital Cinema security system.

### 9.3.1. Definitions

- **Content** – The digital representation of a visual, audio or subtitled program. Content exists in several forms (encrypted/plaintext, compressed/uncompressed, etc) at various stages of the process in the Digital Cinema system.
- **Digital Cinema Package (DCP)** – The standardized form of content intended for delivery to theatrical exhibition facilities. DCP content components are selectively encrypted by the Rights Owner.
- **Equipment Suite (Suite)** – A set of security devices (including one Security Manager) that collectively support playback for a single auditorium.
- **Extra-Theater Message (ETM)** – One-way information packet that passes into or out of, the

- 
- exhibition facility. The ETM is a generic message container.
- **Forensic Mark** – The generic term used in this specification for any or all of the following: watermarking, fingerprinting, and/or forensic watermarking functions used at the time of playback.
  - **Intra-Theater Message (ITM)** – The data packet that passes between security devices assigned to a single auditorium. ITM(s) operate on two-way channels.
  - **Key Delivery Message (KDM)** – The Extra Theater Message (ETM) for delivering content keys and Trusted Device List (TDL) to exhibition locations.
  - **Log Data** – The data produced and stored as a result of security system activity.
  - **Media Block (MB)** – A type of security device that performs media decryption.
  - **Rights Owner** – The generic term used to describe the party having authority over content to negotiate terms of engagements (e.g., a studio or distributor).
  - **Screen Management System (SMS)** – A (non-secure) Security Entity (SE) that directs security functions for a single auditorium on behalf of exhibition management.
  - **Security Data** – The keys and associated parameters required for access to content, and managed by Security Managers.
  - **Security Entity (SE)** – A logical processing device which executes a distinct security process or function. SEs are not distinguished from other theater equipment by being physically secure, but by the specific security function that they perform (see Section 9.3.3 Security Messaging and Security Entities).
  - **Security Interface** – A standardized point of interoperability for security messaging.
  - **Security Management** – The process of securely distributing, storing and utilizing Security Data in order to access content.
  - **Security Manager (SM)** – *A conceptual device Security Entity (SE) that controls Security Data according to a defined policy. Wherever this term is used, it shall be understood that an SM is installed in each auditorium, and each reference is to an auditorium SM.*
  - **Stakeholder** – A party involved in a business agreement relating to distribution and exhibition of specific Content.
  - **Trusted Device List (TDL)** – A list of specified security devices which are approved to participate in playback of a particular composition at the exhibition facility.

### 9.3.2. Security Management Approach to Security

The security architecture described herein distinguishes security management from content management. Once content is encrypted, it is “purpose neutral and safe” and can be allowed to take any path desired at any time to any destination. Thus, content management (physical distribution) can be implemented along lines that are oriented towards business needs, commercial cost effectiveness, and convenience. “Purpose neutral and safe” means once content is encrypted, its purpose has been neutralized (as to the content type, information contained, etc.) and it is safe (one does not care where it goes, how it gets there or who has access to it).

---

Access to encrypted content is controlled by the security management function. That is, content access is enabled or denied through control of Security Data. This function is entrusted to a Security Manager (SM), a logically separable and functionally unique component of the architecture. At exhibition, the SM controls Security Data, and consequently, access to content.

In the theater, Digital Cinema systems will have an SM assigned to each auditorium/projector. For each playback, each SM will require, and be delivered, one or more unique keys to unlock encrypted content files. All distributors will share this SM.

Each key is delivered in a Key Delivery Message (KDM) with a specified play period. That is defined as the time window when the key is authorized to unlock the content. There is a start time/date and a stop time/date associated with each key. The authorized window for each key will be part of the normal engagement negotiation between Exhibition and Distribution. The Security Manager will authenticate the identity and integrity of the auditorium security equipment for each showing, and thereafter enable the use of the appropriate keys during the authorized play window.

### 9.3.3. Security Messaging and Security Entities

The security system described herein implements a standardized open architecture in which equipment used at exhibition facilities can be sourced from multiple, competing suppliers. In order to achieve interoperable security operation, the security system design for Exhibition, specifies a standard message set for interoperable communications between standardized security devices.

#### 9.3.3.1. Security Messages

There are two classes of messages in the architecture:

- **Extra-theater Messages (ETM)** – These are self-contained one-way messages that move Security Data and information outside or within the theater. These specifications have defined a fundamental message structure for a generic ETM, the requirements for which are normative and given in Section 9.8
- **Intra-theater Message (ITM)** – Messages that move security information within the auditorium over a real-time two-way channel. Requirements for the ITM infrastructure are given in Section 9.4.5 Intra-Theater Communications.

Figure 14: shows typical locations of SM functions<sup>6</sup>, ETM<sup>7</sup> and ITM message interfaces. ETM message types are labeled with a black 1 and ITM messages with a red 2.

---

<sup>6</sup> There may be various types of SM functions. These specifications are focused on the auditorium SM and its security management roles. SM functional and behavioral requirements are specified in Section 9.4.3 Theater Security Operations

<sup>7</sup> The KDM is a type of ETM, and its creation location may vary. The KDM is normatively specified in Section 9.8

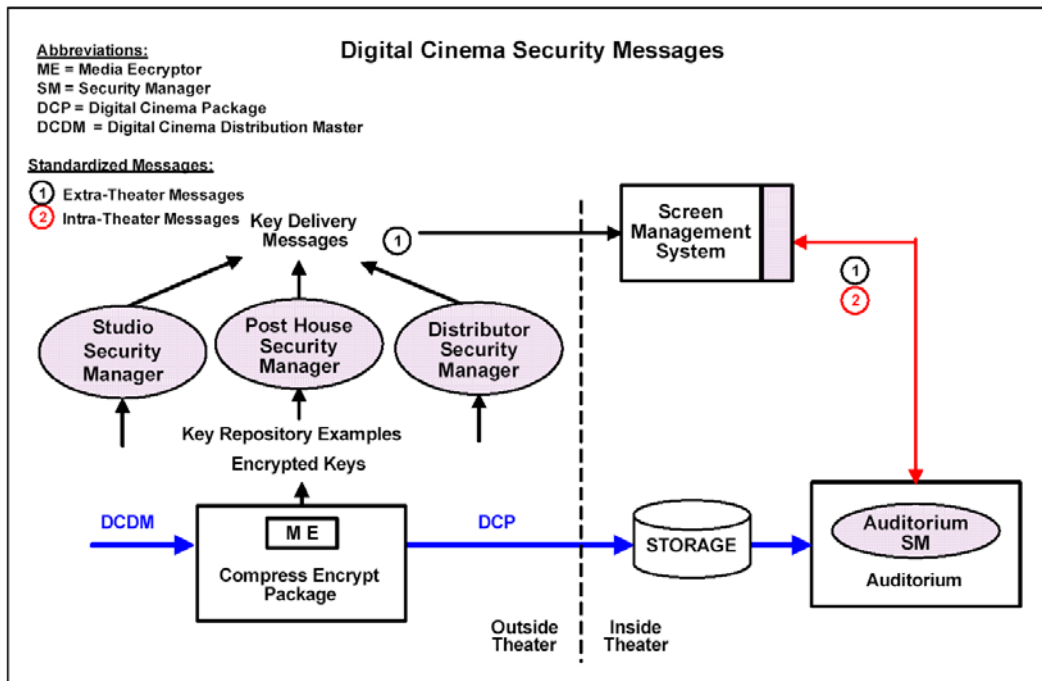

**Figure 14: Digital Cinema Security Message Flow**

### 9.3.3.2. Security Entities

Security Entities (SE) are characterized by executing in a narrowly defined security function, and having a role defined for them in a digital certificate with which they are associated. *The seven defined SE(s) are as follows (these are developed more fully in Section 9.4 Theater Systems Security).*

1. *Screen Management System (SMS) – The SMS is not a secure device and therefore is not trusted to handle Security Data (keys). The SMS is trusted to send/receive commands to/from the auditorium SM, such as those required to prepare an equipment suite for playback.*
2. *Security Manager (SM) – Responsible for Security Data (keys) and Digital Rights Management within a defined sphere of control (see Section 9.6.2 “Trust” and the Trusted Device List (TDL))*
3. *Media Decryptor (MD) – Transforms encrypted (image, sound, etc.) content to its original plaintext form*
4. *Link Encryptor (LE) – Encrypts content transmission over links between physical devices in exhibition*
5. *Link Decryptor (LD) – Decrypts content encrypted by a Link Encryptor (LE)*
6. *Forensic Marker (FM) – Inserts markings (data indicating time, date and location of playback) in both image and audio essence in realtime at time of playback (i.e., a fingerprint or watermark inserter)*

- 
7. *Secure Processing Block (SPB) – A Security Entity (SE) whose security function is to provide physical protection to other SEs contained within it. A Media Block is an example of a SPB. These specifications define two types of SPB physical protection perimeters (see Section: 9.4.2.2 The Secure Processing Block (SPB)).*

Security Entity Notes:

- *The term Security Entity should not be confused with secure entity. The term secure entity is not normatively defined or used in these specifications, as the SPB function serves this purpose, and is normatively defined.*
- *The Link Encryptor and Link Decryptor Security Entities exist only when Link Encryption is used.*
- *The SMS is not a secure device, and is sometimes viewed as part of the media server, or as part of the TMS. These security specifications focus on the SMS as the auditorium controlling device, independently of its scope or totality of other functions it may provide (see Section: 9.4.2.5 Screen Management System (SMS)).*

## **9.4. Theater Systems Security**

### **9.4.1. Theater System Security Architecture**

The Theater System is comprised of those components, at an Exhibition location, that are required by the security system to support playback of a show. Once in possession of the complete DCP and its associated KDMs, the theater security system can independently enable playback of the composition.

Theater System Security requirements are:

1. *Each auditorium shall have one authenticating Media Block, containing an auditorium SM that Rights Owners will share. The authenticating MB shall be the Image Media Block (IMB).*
2. *The auditorium SM shall have knowledge of the projector it enables, by being able to authenticate that the projector has been certified to meet content protection requirements. Authentication shall be assured via a projector certificate, which shall be associated with the projector's SPB type 2 (see Section 9.5.1 Digital Certificates and Section 9.5.2 Robustness and Physical Implementations).*
3. *Every IMB shall include image, audio and subtitle decryption capability.*
4. *Every IMB shall include image and audio Forensic Marking (FM) capability.*
5. *If Link Encryption (LE) exists, the Link Decryptor (LD) Block shall be authenticated to the IMB SM. Forensic Marking within an LD Block shall be optional.*

- 
6. *Image Media Blocks and Link Decryptor Blocks shall be of the SPB type 1 (see Section 9.4.2.2. The Secure Processing Block (SPB)), and shall be field replaceable, but non-field serviceable.*<sup>8</sup>
  7. *Secure Processing Block (SPB) devices (and the SEs contained within them) shall have normative security and operational behavior requirements specified. Security Managers shall monitor the functioning of all SPB/SE devices and invoke controls to prevent use of improperly operating security equipment. To the extent possible, all security devices shall be designed with self-test capability to announce and log failures and take themselves out of service.*

Figure 15 presents the two fundamental auditorium security system architectures, with and without Link Encryption, and the security message types ETM and ITM. This diagram does not attempt to detail functions that are unrelated to security (e.g., decoding), but does anticipate such functions by noting where plain text content exists.

*Though not shown in Figure 15: Digital Cinema Auditorium Security Implementations, but as indicated in the requirements above, every auditorium shall support image, audio, and subtitle decryption<sup>9</sup>, and image and audio Forensic Marking.*

Additionally, for so called "Special Auditorium Situations," an auditorium equipment suite may enable the use of more than one projection system associated to a single screen in a given auditorium, multiple Link Encryption stages and/or an LD/LE SPB image processing device (see Section 9.4.4.1 "Special Auditorium Situations").

#### **9.4.1.1. Architecture Description and Comments**

The security architecture descriptions and requirements revolve around two embodiments: the SPB and the SE. As defined in Section 9.3.3 Security Messaging and Security Entities, SEs are logical devices that perform specific security functions. They are logical because these specifications do not dictate how SEs are actually designed, and more than one type of SE may be implemented within a single circuit.

*All functional Security Entities (SEs) (except the SMS) shall be contained within SPBs, which provide physical protection for the Security Entities (SEs). The SPB is itself a literal SE Type – its security function is physical protection. The Security Entities (SEs) and SPB type 1 and type 2 containers are depicted in Figure 15: Digital Cinema Auditorium Security Implementations. This figure shows that there shall be only three permitted physical protection scenarios:*

- *No physical protection required – Screen Management System (SMS)*

---

<sup>8</sup> "Non-field serviceable" means not serviceable by other than the equipment vendor or his authorized and supervised service repair depot (see Section 9.5.2.3 Repair and Renewal)

<sup>9</sup> Subtitle encryption is directed primarily against interception during transport, and cryptographic protection within the theater is not required. For example, plaintext subtitle content may be transmitted from a server device to a projection unit. It is preferred, but not required, that subtitle content be maintained in encrypted form except during playback.

- 
- *SPB type 1 protection required – Image Media Block (IMB), Link Decryptor Block (LDB) and LD/LE SPB Devices*
  - *SPB type 2 protection required – Content essence entering the projector from an IMB or LD Block*

These requirements are more fully defined in the SM and SPB functional requirements below (see Section 9.5 Implementation Requirements).

The security network is shown (in red) in Figure 15: Digital Cinema Auditorium Security Implementations. This is described below as operating under Transport Layer Security (TLS), a readily available and well known protocol standard for providing protection between application layer processes that must communicate between devices, in this case between auditorium devices (Secure Processing Blocks) performing security functions.<sup>10</sup>

As part of TLS session establishment, each party to the session presents its digital certificate to the other. In this fashion, the IMB Security Manager identifies the other SPBs in the auditorium, and mutual authentication is accomplished (see Section 9.4.3.1 Transport Layer Security (TLS) Establishment and Secure Processing Block (SPB) Authentication and Section 9.4.5.1 Transport Layer Security Sessions, End Points and Intra-Theater Messaging). Although the SM may establish secure TLS communications with an SPB, it will not “trust” (approve) that SPB for content playback functions until the identity of such SPB appears on the appropriate Trusted Device List (TDL) for the particular composition.

The playback processes begins and ends with the SMS, under the control of Exhibition. Thus, the SMS is viewed as the initiator of security functions, and the window into the exhibition security system. Protection over cryptographic processes begins by requiring the SMS to communicate, in a secure fashion (i.e., under TLS), with the Security Managers (SM) under its control. The security system takes advantage of these secure command and control features to protect itself, as well as the exhibition operator, from several forms of attacks, including SMS imposters and Denial of Service.

While it is true that the security system places no physical protection requirements on the SMS, the extent to which the SMS is vulnerable to being tampered with, or its functions subverted, is a result of exhibition implementation and policy (e.g., who gets access to the SMS, how it is physically protected by room locks, operator access). The security system requires the SMS and SMS operator to identify itself to the Security Manager. The extent to which this information is reliable is subject to issues outside the scope of the security system and this specification. But the security system structure and standards requirements are appropriately specified to enable

---

<sup>10</sup> Transport Layer Security (TLS) can be viewed as an extension of the SPB physical protection container, but for communications, a “steel pipe” that surrounds the wire between devices. Thus, these specifications define both physical and logical protection mechanisms for all security and playback processes.

---

policies to regiment these aspects according to any particular security needs, without needing to change or enhance SE device operations or features.



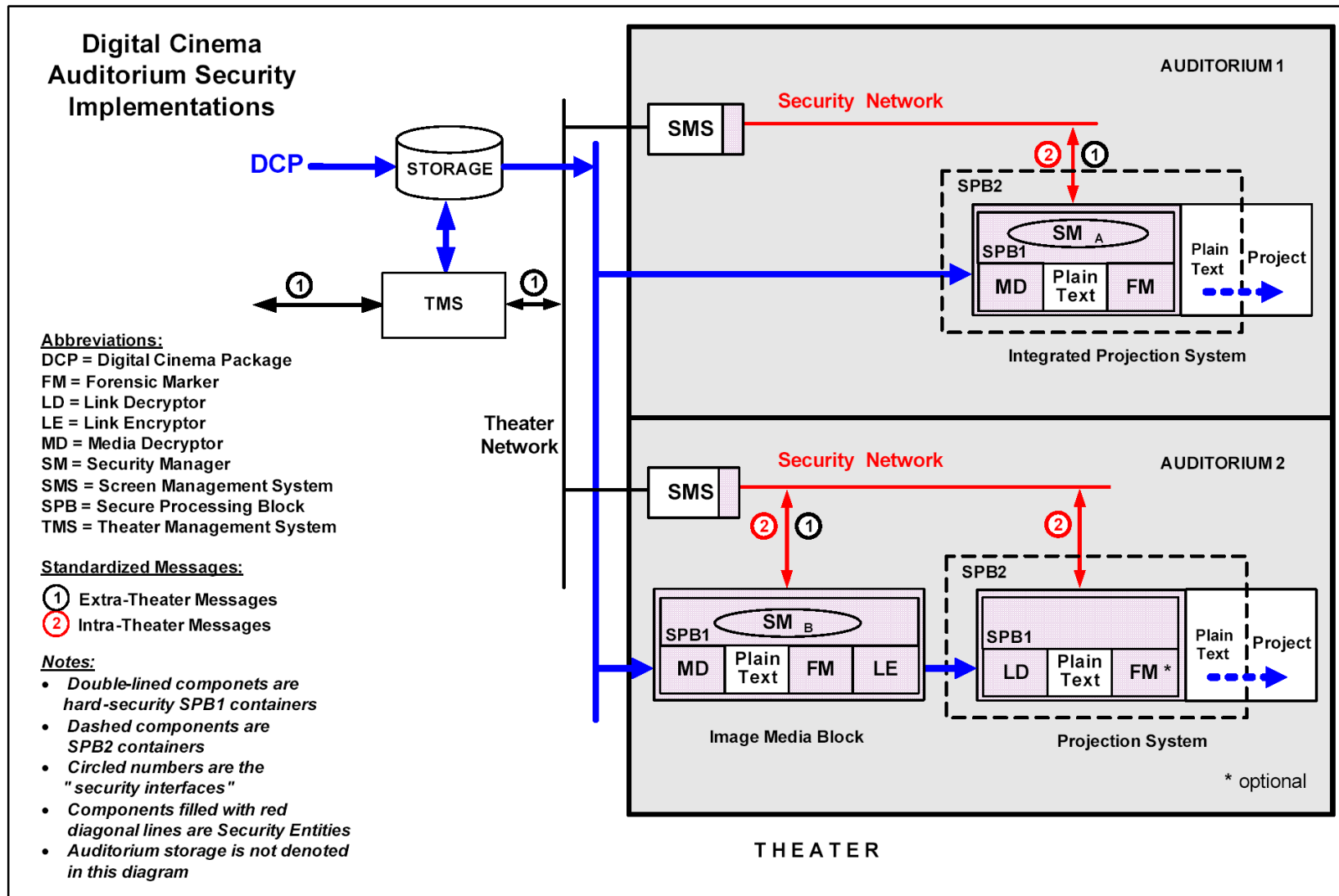

Figure 15: Digital Cinema Auditorium Security Implementations

---

## 9.4.2. Theater System Security Devices

Although SEs are not distinctly visible outside of the SPB that contains them, SEs exist logically, and their normative behavior is specified in conjunction with the requirements defined below for SPB systems (see Section 9.4.3.5 Functions of the Security Manager (SM) and Section 9.4.3.6 Functional Requirements for Secure Processing Block Systems). This is accomplished using a traditional Applications Programming Interface (API) approach, where the focus of the interoperability point is the SPB (logical) interface, and associated messaging and operational behavior at the interface.

### 9.4.2.1. Equipment Suites

*Several SPBs may be grouped to support an auditorium. Security requirements do not define an auditorium per se, but instead refer to a collection of equipment in the display chain as an equipment suite. A playback of a show will be associated with an equipment suite, and that suite must be set up (prepared) by the requisite IMB SM ahead of the show for each playback (see Section 9.4.3.6.3 Normative Requirements: Image Media Block (IMB)) This takes place for each showing by command of the SMS.*

The installation and configuration of equipment that comprises suites is an exhibition management function.

### 9.4.2.2. The Secure Processing Block (SPB)

The SPB is defined as a container that has a specified physical perimeter, within which one or more SE and/or other plaintext processing functions are placed (e.g., decryptor, decoder, Forensic Marker). The SPB exists to enclose SEs and other devices in the content path, impede attacks on those SEs, and to protect signal paths between the SEs.

There are two normatively defined SPB types:

- **Secure Processing Block type 1** – An SPB type 1 provides the highest level of physical and logical protection. *Image Media Blocks and Link Decryptor Blocks shall be contained within a type 1 SPB. (These are shown as double-lined boxes filled with diagonal lines in Figure 15: Digital Cinema Auditorium Security Implementations). Additionally (and not shown in Figure 15) the LD/LE SPB Device shall be contained within a type 1 SPB.*
- **Secure Processing Block type 2** – An SPB type 2 provides a lesser perimeter of protection, for content or security information that does not require the full SPB type 1 protection. *SPB type 2 protection shall be provided by projectors as shown as the dotted line around the SPB type 1 devices as shown in Figure 15.*

*Secure Processing Blocks (SPBs) shall provide a hard, opaque physical security perimeter that meets minimum security requirements as defined in 9.5.2 Robustness and Physical Implementations. Both SPB types are considered a Security Entity (SE), and shall be assigned a digital certificate per Section 9.5.1 Digital Certificates*

---

### 9.4.2.3. Media Blocks (MBs)

The term Media Block<sup>11</sup> (MB) has been used by the Digital Cinema industry in a number of ways. In this Section 9 SECURITY, it has a very narrow scope: An MB is an SPB that performs essence decryption, i.e., it contains at least one MD. *Other SE functions may also be present within a MB SPB, as described below:*

- **Image Media Block (IMB)** – *The Image Media Block (IMB) is a type of Secure Processing Block (SPB) that shall contain a Security Manager (SM), Image, Audio and Subtitle Media Decryptors (MD), image decoder, Image and Audio Forensic Marking (FM) and optionally Link Encryptor (LE) functions. The IMB SM is responsible for security for a single auditorium, and it authenticates other SPBs that are required to participate in showings. Other such SPBs are referred to as remote or external SPBs.*
- **Remote Media Block** – *A remote Media Block is a remote SPB that contains other types of MDs, such as those used for audio or subtitles, but does not contain an SM. Remote Media Blocks shall not be used in DCI compliant systems.*

### 9.4.2.4. Security Manager (SM)

The SM controls Security Data and content access in a manner consistent with the policies agreed upon by the Stakeholders who rely upon it. *There is one SM for each auditorium, and it shall be contained within the IMB. The Rights Owners (Distribution) shall share this SM for their security needs.*

*Security Manager functions shall conform to the requirements as given in Section 9.4.3.5 Functions of the Security Manager (SM) and Section 9.6.1 Digital Rights Management. The Security Manager is a self-contained system with an embedded processor and real-time operating system. SM functions shall not be implemented outside of the secure environment of the Image Media Block (IMB) SPB.*

The Security Manager is a self-contained processor running a real-time operating system. *The operating environment shall be limited to the FIPS 140-2 limited operational environment category (Section 9.5.2.5 FIPS 140-2 Requirements for Type 1 Secure Processing Blocks), meaning that the SM's operation shall not be modifiable in the field. The only security communication with systems (processors) external to the SM's SPB shall be by Transport Layer Security (TLS) over a network interface per Section 9.4.5.1 Transport Layer Security Sessions, End Points and Intra-Theater Messaging. The preferred real time operating system would use the National Security*

---

<sup>11</sup> In Section 7 THEATER SYSTEMS Media Blocks are also discussed. The terminology used there is not strictly security focused, because other important equipment requirements such as storage and server functions are discussed. Depending upon a particular design, server functions may well be part of what is in a MB, when viewed in its entirety. Since other such functions are invisible to security, they need not be discussed within the security arena, and are not addressed in this security chapter.

---

Agency (NSA) kernel and would be specifically designed for secure operations.. *The Security Manager software shall use all appropriate security features of the operating system.*

Security Manager software changes and upgrade requirements are given in Section 9.5.2.7 SPB Firmware Modifications.

#### **9.4.2.5. Screen Management System (SMS)**

Theater management controls auditorium security operations through the Screen Management System (SMS). Because the SMS interacts and communicates directly with the security system, per Section 9.3.3.2 item 1, it is also considered to be a Security Entity (SE). The SM responds to the directives that Theater Management System (TMS) issues via the SMS. For purposes of simplicity, and subject to the TMS constraint below, this specification uses the term SMS to mean either/both Theater Management System (TMS) or Screen Management System (SMS). From the security system perspective, SMS functions are those associated with “category 1” Intra-Theater Messages of Table 15: Intra-theater Message (ITM) Request-Response Pairs (RRP).

SMS Requirements:

- *The SMS shall carry a DCI compliant digital certificate (see Section 9.5.1) to identify the SMS entity to the SM. The SMS certificate shall indicate only the SMS role unless the SMS is contained within a SPB meeting the protection requirements for any other designated roles.*
- *The SMS digital certificate may be permanent to the SMS, or “operator certificates” may be assigned to designated personnel (e.g., using a dongle, smart card, etc.) for association with the SMS.*
- *In the event that Exhibition command and control designs include the TMS as a device that interfaces with the SMSs, such a TMS shall be viewed by the security system as an SMS, and it shall carry a digital certificate and follow all other SMS behavior, Transport Layer Security (TLS) and Intra-Theater Message (ITM) communications requirements.*
- *Identification of the SMS operator for purposes of the “AuthorityID” field (see Section 9.4.5.2.4) shall be by:*
  - *Certificate thumbprint, where “operator certificates” are used, or*
  - *Username/password or the like, as specified by exhibition management.*

SM interaction with the SMS<sup>12</sup> is normatively defined (see Section 9.4.3.5 Functions of the Security Manager (SM)). *These include the requirements that:*

---

<sup>12</sup> SMS-to-SM Intra-Theater Message (ITM) commands (see Section 9.4.5.3.1 Screen Management System to Security Manager Messages) include means to carry SMS operator identification via the “AuthorityID” field. The specific operational policies used at exhibition that surround operator identification, empowerment or enforcement are outside the scope of this specification.

- 
- *The SM provides log records identifying the SMS for which it operates, as well as the AuthorityID field. In the case where “operator certificates” are used, this information is the same (i.e., the digital certificate thumbprint).*

#### **9.4.2.6. Projection Systems**

From the security perspective, a projection system consists of the projector type 2 Secure Processing Block (SPB) and its “companion” SPB, which will be either the Link Decryptor Block (LDB) or Image Media Block (IMB). A critical security issue is assuring that the clear text image output of the LDB or IMB goes to a legitimate projection device.

Therefore Section 9.4.3.6.1 Normative Requirements: Projector Secure Processing Block defines a “marriage” process with the companion SPB. The marriage, in conjunction with the Trusted Device List (TDL) and TLS-based authentication of the companion and projector SPBs, addresses the legitimate projector security issue.

The purpose of the marriage is to have a human authority figure supervise the installation of a projection system to assure the physical connection of the two SPBs, which TLS-based authentication alone cannot do. At the time of installation the authority figure can provide visual inspection of the projector to assure it has not been tampered with.

Once a projector is installed, the state of marriage is permanent (and monitored) until the authority figure decides to separate the two SPBs (for whatever reason). In addition, this specification establishes logging requirements surrounding projector installation and maintenance functions that record security-critical event information.

*It is mandatory that a projection system installation includes the marriage function per Section 9.4.3.6 Functional Requirements for Secure Processing Block Systems (noting the permanently married exception provided for in that section). The marriage process shall require the supervision of a human authority figure, who shall examine projectors as part of the marriage process to assure the associated SPB has not been tampered with.*

#### **9.4.3. Theater Security Operations**

This section describes how equipment conforming to the security system is used in normal theater operations. The show, expressed in a Show Playlist, consists of exhibition-arranged sequences of compositions, any of which may be encrypted. One or more Rights Owners may supply Key Delivery Message(s) (KDMs) to provide all the content keys required for the Show Playlist.

With respect to security, theater operations break down into four categories:

1. Secure communications establishment and Secure Processing Block (SPB) device authentication
2. Pre-show preparations
3. Playback
4. Post playback

---

The SMS is generally responsible for initiating activity within each category, except the last.

#### **9.4.3.1. Transport Layer Security (TLS) Establishment and Secure Processing Block (SPB) Authentication**

Exhibition has the liberty to power their equipment up and down as desired. *However, the Security Managers (SM) must authenticate the equipment within their respective suites, and establish secure Transport Layer Security (TLS) sessions with each remote SPB with each power-on.*

Note that the establishment of each TLS session enables the SM to authenticate the other party (SPB or SMS) to the session and provides for secure ITM communications within the auditorium. The SM does not “trust” such party for security functions related to content playback, unless the identity of the party appears on the Trusted Device List (TDL) delivered in the Key Delivery Message (KDM) for that particular Composition Playlist (CPL) (see Section 9.4.3.5 Functions of the Security Manager (SM) and Section 9.8 Digital Certificate, Extra-Theater Messages (ETM), and Key Delivery Messages (KDM) Requirements). Thus, device authentication and secure communications occurs independently of “trust”; the former being an exhibition equipment/infrastructure security issue, the latter being specific to a Rights Owner and a composition. Where content is not encrypted and no KDM/TDL exists, the SM does not invoke trust control.

The flow chart in Figure 16: System Start-Up Overview, is an example of how a system start-up may occur. This flow chart is informative. There are other designs that may have different steps or different sequences that will accomplish the same result and meet the requirements of this specification.

## System Start-Up Overview

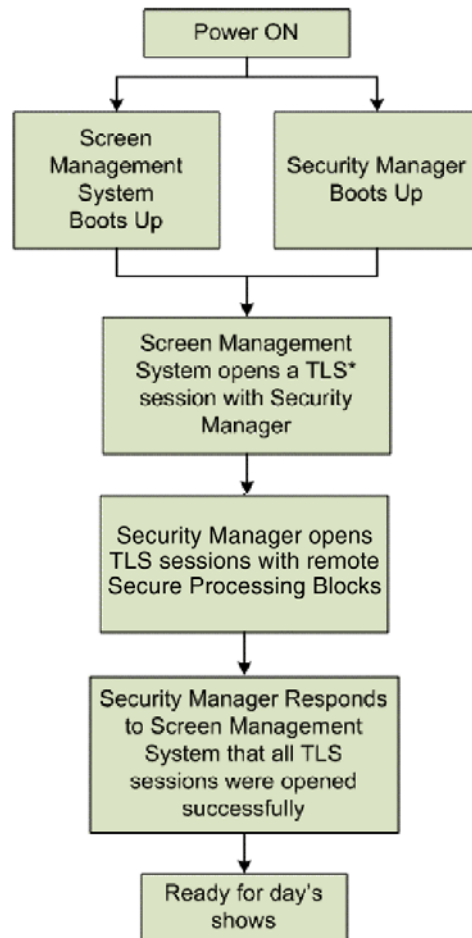

\*TLS = Transport Layer Security

Figure 16: System Start-Up Overview

### 9.4.3.2. Pre-show Preparations

Pre-show preparations include tasks to be performed (well) in advance of show time to ensure adequate lead-time to resolve any issues that might impact the composition showing. These preparations do not prepare an auditorium for a showing, but are designed to provide assurance that all prerequisites for a specific showing have been satisfied.

- **Composition Playlist (CPL) check(s)** – *Composition Playlists (CPL) shall be validated by the Security Manager participating in the respective composition playback.*
- **Composition decryption preparations** – *Each encrypted composition will have associated with it a Key Delivery Message (KDM), carrying time window constraints, decryption keys, and a Trusted Device List (TDL). The SMS, working with the security infrastructure, shall verify that the content keys required for playback are available and valid for scheduled exhibitions, and the suite equipment to be used for playback is on the TDL.*

- **Show playback preparations** – Exhibitors will assemble Show Playlists specific to each exhibition event, containing various compositions (including advertising, trailers, movies, etc.). *Because the final Show Playlists may involve many content keys and/or consist of content from different Rights Owners, show preparations should ensure the auditorium SM has confirmed possession of all necessary Key Delivery Message(s) (KDMs) for the Show Playlist. In addition, FM devices may require configuration (keying) by the SM.*

The flow chart in Figure 17: Pre-Show Overview, is an example of how a system may prepare to execute a Show Playlist. This flow chart is informative. There are other designs that may have different steps or different sequences that will accomplish the same result and meet the requirements of this specification.

### Pre-Show Overview

Note: While not a security function, it is assumed that the Exhibitor has created a Show Playlist for each auditorium

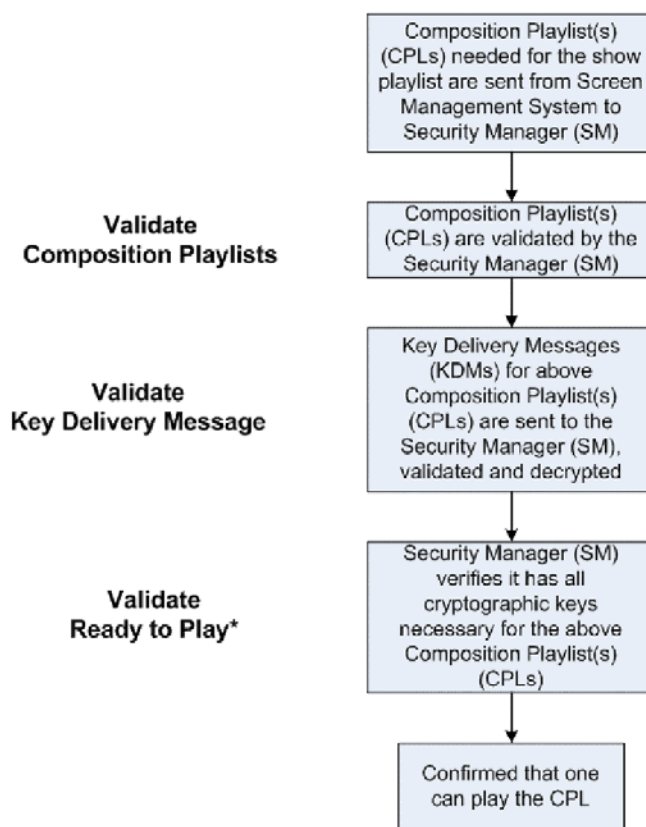

\*"Ready to Play" may optionally include Key Delivery Message (KDM) payout window and/or Trusted Device List (TDL) checks

**Figure 17: Pre-Show Overview**



---

### 9.4.3.3. Show Playback

Show playback processes include auditorium preparations for the playback of a specific Show Playlist, and the actual run-time security functions that include content decryption at the Media Decryptor(s), link encryption/decryption, forensic marking, and recording of log data.

- **Equipment suite preparations** – *The SM shall prepare the suite for playback prior to each composition showing. This shall include validation of the authenticity and "trust status" of the suite SPBs, and delivery of all necessary keys per Section 9.4.3.5 Functions of the Security Manager (SM). SMs shall obtain trust status by confirming that the SPBs are listed in the TDL delivered as part of each KDM required for the entire Show Playlist. Different compositions may have different requirements and the system shall check the SPBs against the TDL for each composition independently.*
- **Streaming media decryption** – Playback of a show consists of a concatenation of compositions that require serial or (separately) parallel decryption. One or more Media Decryptors (e.g., for image, audio or subtitle) may be involved.
- **Link Encryption (LE) and Link Decryption (LD)** – *If Link Encryption is used, the SM shall support keying of LE and LD Security Entities.*
- **Forensic Marking** – *Each MB shall apply Forensic Marking to image and audio data during playback.*
- **Log data recording** – *Remote SPBs shall capture and transfer log records to the Image Media Block (IMB) SMs as specified in Section 9.4.6.3 Logging Subsystem.*

The flow chart in Figure 18: Show Playback Overview, is an example of how a system may execute a Show Playlist. This flow chart is informative. There are other designs that may have different steps or different sequences that will accomplish the same result and meet the requirements of this specification.

## Show Playback Overview

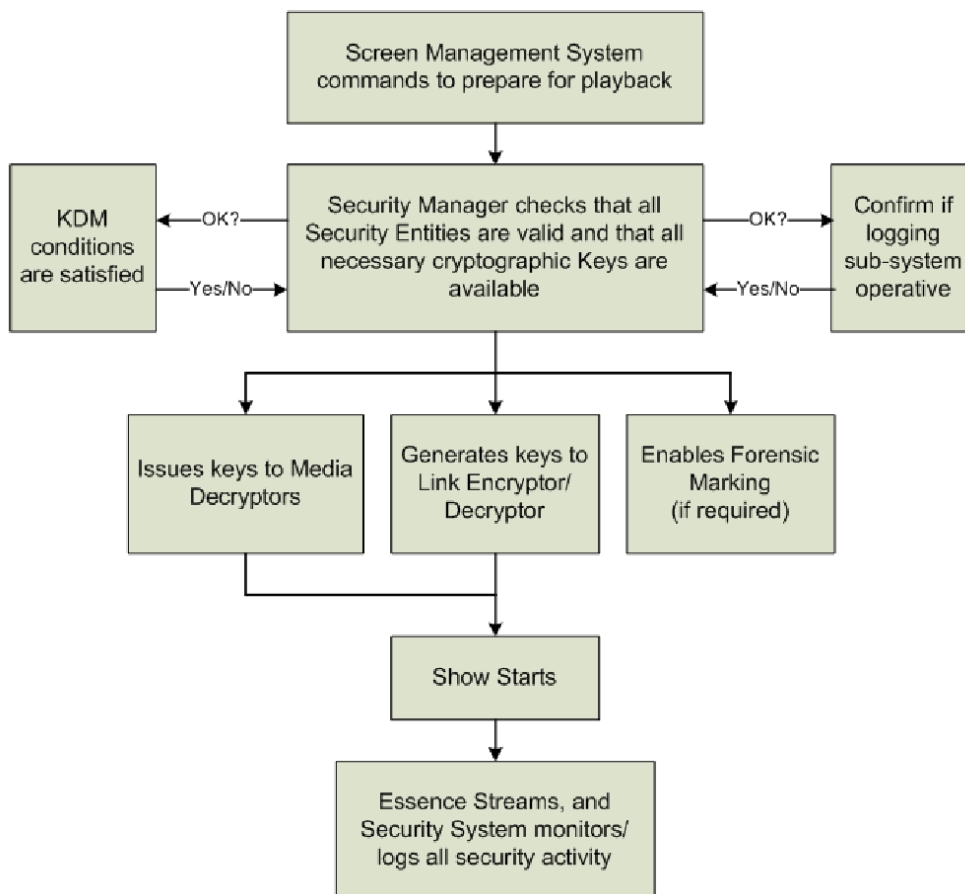

Figure 18: Show Playback Overview

### 9.4.3.4. Post Playback

Post playback activity primarily includes cleansing SPBs of sensitive data and collection of log data.

- **Media Decryptor and Link Decryptor content key zeroing** – MDs and LDs shall honor a validity duration period supplied with the keys provided by the SM, after which playback keys shall be purged<sup>13</sup> from the respective SE.
- **Collection of log data** – The Image Media Block SM shall be responsible for collection of all playback event log data from SPBs within the playback suite it supports per Section 9.4.6.3 Logging Subsystem.
- **Purge Suite** – The SMS shall be able to invoke a process that cleanses a suite of

<sup>13</sup> As used above and elsewhere in these specifications, the term purge shall mean the data is permanently erased or overwritten such that it is unusable and irrecoverable (also known as “zeroization” in FIPS 140-2).

---

*specific KDM content keys and suite preparations.* This would be used as a last minute decision to change auditoriums, and/or to recover SPB memory storage, for example.

There are no end of engagement requirements placed on the security system. Exhibition may cleanse Screen Management System (SMS) or Theater Management System (TMS) devices, content storage devices, Key Delivery Message(s) (KDMs), etc. according to their own operational needs. Defined security system behavior places controls on Security Data, keys, etc. such that security interests are maintained.

The flow chart in Figure 19: Post Playback Overview, is an example of those items a system performs following a completed Show Playlist. This flow chart is informative. There are other designs that may have different steps or different sequences that will accomplish the same result and meet the requirements of the specification.

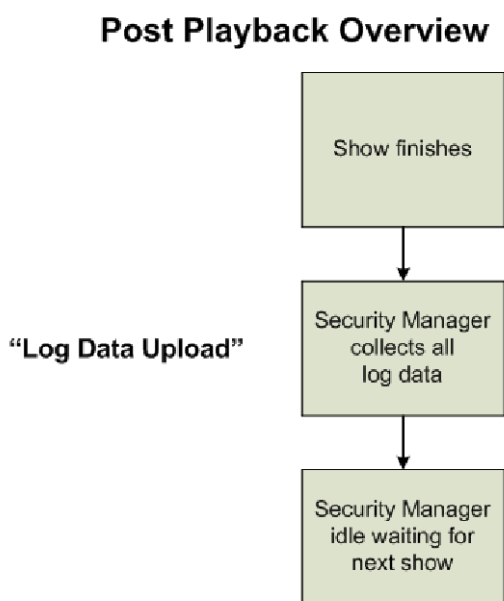

**Figure 19: Post Playback Overview**

#### **9.4.3.5. Functions of the Security Manager (SM)**

Auditorium Security Managers (SMs) are responsible for overseeing the security aspects of the auditorium they are assigned to (installed in). Each SM operates independently from other SMs in responding to the auditorium’s Screen Management System (SMS) to enable playback of content. The required SM functions are described below.

In listing these functions the approach is that of a reference model for SM behavior, meaning that these specifications do not define required implementation methods. A standards-compliant implementation must, however, have the same input/output behavior as the reference model.

---

### **Security Manager (SM) Functions:**

1. *Receive, store, decrypt and validate Key Delivery Message(s) (KDMs) per the three validity checks of Section 6.1.2 of the KDM specification (SMPTE430-1: D-Cinema Operations - Key Delivery Message). Constrain use of KDM content keys per item 9 below to the SM's confirmation that one of the certificates in the signer chain of the associated Composition Play List (CPL) has a thumbprint that matches the ContentAuthenticator element of the KDM, per Section 5.2.4 of said KDM specification.*
2. *Security Manager (SM) KDM usage policy is specified as follows:*
  - a. *Playout shall be fully supported by a single KDM, inclusive of all required essence keys and playout time window (i.e., a playout shall not occur that requires the combination of two or more KDMs).*
  - b. *For any given composition, playout shall be enabled for any start time that is within the KDM's time window.*
  - c. *To avoid end of engagement issues, a show time's playout may extend beyond the end of the KDM's playout time window, if started within the KDM playout time window, by a maximum of six (6) hours.*
  - d. *Excepting the requirements of item 2c above, the SM shall delete any KDM and associated keys for which the playback time window has expired (passed).*
3. *Reject ETM messages that are not recognized as DCI compliant standardized messages.*
4. *Validate Composition Playlists (CPL), and log results as a prerequisite to preparing the suite for the associated composition playback. For encrypted content, validation shall be by cross checking that the associated KDM's ContentAuthenticator element matches a certificate thumbprint of one of the certificates in the CPL's signer chain (see item 1 above), and that such certificate indicate only a "Content Signer" (CS) role per Section 5.3.4, "Naming and Roles" of the certificate specification (SMPTE430-2 D-Cinema Operation - Digital Certificate).*
5. *Process essence (i.e., Track File frame) integrity pack metadata for image and sound during show runtime. Integrity pack deviations (including HMAC, as applicable) detected during playback shall be logged; however, per Section 9.6.1.2 "Digital Rights Management: Security Manager" Table 21, playback should not be prevented or interrupted. For clarity purposes, integrity pack metadata is defined as Track File ID, Frame Sequence and calculated Message Integrity Code (MIC) information to be compared against the reference data contained in the associated CPL. Log information necessary to detect deviations (including restarts) from the actual playback sequence from the Track File ID and reel sequence specified in the CPL as follows:*
  - a. *Image – Process integrity pack information, with the exception that the frame hash (HMAC) check is encouraged but optional.*
  - b. *Audio – Process integrity pack information, including the hash (HMAC).*
6. *[This item left blank intentionally.]*

- 
7. *Perform remote Secure Processing Block (SPB) and Screen Management System (SMS) authentication through Transport Layer Security (TLS) session establishment, and maintain the certificate lists so collected.*
    - a. *Associate certificate lists with TDLs delivered in KDMs per Section 5.2.5 of the KDM specification (SMPTE430-1: D-Cinema Operations - Key Delivery Message) to support the identification of security devices that are trusted/not trusted.*
    - b. *Maintain TLS sessions open for not more than 24 hours between complete restarts (i.e., forces periodic fresh TLS keys). Perform proxy mode of authentication for projection systems per Section 9.4.3.6.5.*
    - c. *Content owners may optionally allow the SM to automatically assume trust in remote SPBs (i.e., have the SM trust security devices without their certificate information appearing on the TDL). To support this feature, a unique "assume trust" certificate thumbprint is specified as the "SHA-1 of the empty string". The Base64 value of this string shall be "2jmj7I5rSw0yVb/vIWAYkK/YBwk=" for this exclusive use. When the KDM's DeviceList carries exclusively (only) the assume trust thumbprint, the SM shall consider the auditorium suite certificates collected during TLS session establishment as being "on the TDL." In other words, the SM shall act as if the TDL requirement has been satisfied. SM behavior shall otherwise follow all rules of this section. Should the KDM's DeviceList carry any thumbprint in addition to the assume trust thumbprint, the SM shall ignore this part (c) rule. The assume trust thumbprint shall not be used to enable Special Auditorium Situations per item 16 below.*
  8. *Support TLS-protected ITM standards per Section 9.4.5.2 Intra-Theater Message Definitions. ITM functions shall include:*
    - a. *Maintain TLS sessions with suite SPBs (including the SMS),*
    - b. *Querying/receiving status of other SPBs external to the SM's Media Block,*
    - c. *ITM usage and operational behavior means with respect to item 8a and item 8b, sufficient to detect any equipment substitutions,*
    - d. *Reporting status on CPL playability, suite readiness and other SM and SPB conditions to the SMS,*
    - e. *Movement of security (or security related) information (e.g., content keys and LE keys, logging data, secure time).*
  9. *Prepare and issue content keys to Media Decryptor (MD) and Forensic Marking (FM) SEs as may require keying per the CPL. Constrain use of keys to:*
    - a. *Confirmation (via QuerySPB command) that TLS connections are operative with remote SPBs, and that the QuerySPB Response "general response" element indicator is "0" (RRP successful).*
    - b. *Usage validity periods of six (6) hours for remote SPBs (in line with the rule of item 2c above).*

- 
- c. *Authenticated and trusted Secure Processing Blocks (SPBs (per item 7 above). The system shall check the SPBs against the TDL for each composition independently.*
  - d. *[This item left blank intentionally.]*
  - e. *Specific MDs matching the key type IDs as designated by the KDM, per Section 5.2.8 of the KDM specification (SMPTe430-1: D-Cinema Operations - Key Delivery Message).*
  - f. *Receipt by the SM of a valid CPL for the composition being prepared for playback per item 4 above.*
10. *Support Link Encryption (LE) keying (if link encryption is used) by:*
    - a. *Generating unpredictable keys per Section 9.7.6 Key Generation and Derivation and having a usage validity period on a per-showing basis (i.e., each playout of an encrypted composition requires a new LE key.) which is generated per item 11 below.*
    - b. *Transferring LE keys only to an authenticated and trusted (per item 7 above) Link Decryptor Security Entity (SE) function.*
    - c. *Support link encryption operational processes for combinations of clear and encrypted content according to Section 9.4.4 Link Encryption.*
  11. *Perform suite playback preparations per items 9 and 10 above for each showing, within 30 minutes prior to show time. Though item 9 above establishes key validity periods of six hours, security equipment integrity checks and suite re-keying shall be executed within 30 minutes prior to each show time.*
  12. *Maintain secure time for a specific auditorium, including SPB time synchronization requirements per Section 9.4.3.7 Theater System Clocks and Trustable Date-Time.*
  13. *Execute log duties for the assigned auditorium per Section 9.4.6.3 Logging Subsystem.*
  14. *Execute Forensic Marking (FM) control operations per Section 9.4.6.2 Forensic Marking Operations*
  15. *During all normal operating conditions (including during playback), continuously monitor and log integrity status of remote SPBs so as to preclude delivery of keys/content to, or playback on, compromised or improperly operating security equipment. To support this requirement the QuerySPB command (see Section 9.4.5. Intra-Theater Communications) shall be issued to each remote SPB at least every 30 seconds whenever TLS sessions are open. Receipt of a QuerySPB response indicating a "security alert" condition shall be indicative of a faulty SPB, and shall prevent or terminate playback per the DRM requirements of Section 9.6.1 Digital Rights Management. Once a show has started, failure of a TLS link shall not cause termination of a show (i.e., QuerySPB commands will not successfully execute, but the show should continue to play if possible).*
  16. *Support suite playback such that no more than one projection system is enabled, except for content owner-approved Special Auditorium Situations per the requirements of Section 9.4.4.1 "Special Auditorium Situations"*

---

17. The SM shall be “*playout aware*”, meaning it shall have real-time knowledge of the occurrence of playout start and end periods. Secure Processing Block behavior and suite implementations shall permit the SM to prevent or terminate playback upon the occurrence of a suite SPB substitution or addition since the previous suite authentication and/or ITM status query. The SMs shall respond to such a change by immediately purging all content and link encryption keys, terminating and re-establishing: a) TLS sessions (and re-authenticating the suite), and b) suite playability conditions (KDM prerequisites, SPB queries and key loads). Perform the security equipment integrity checks and suite re-keying per item 11 above prior to the next playback.

18. Perform and log all the above functions under the operational (not security) control of the particular SMS designated by the exhibition operator per Section 9.4.2.5 Screen Management System (SMS).

#### **9.4.3.6. Functional Requirements for Secure Processing Block Systems**

Each type 1 Secure Processing Block (SPB) can be considered an SPB system, since it operates as a collection of SEs. Similarly, the projector also has its associated type 2 SPB, which does not contain SEs, but fulfills security functions as described below. (Secure Processing Block types are defined in Section 9.4.2.2 The Secure Processing Block (SPB).) In order to facilitate a composition playback, SPBs constituting the suite must work in a coordinated fashion under control of the suite’s SM, contained within the Image Media Block (IMB).

Functional requirements of the SM are defined in Section 9.4.3.5 Functions of the Security Manager (SM). This section defines the functions and operational requirements for the following SPB systems:

- Projector Secure Processing Block (SPB)
- Link Decryptor Block (LDB) Secure Processing Block (SPB)
- Image Media Block (IMB) Secure Processing Block (SPB)
- LD/LE Device Secure Processing Block (SPB)

*In addition to the specific requirements given for SPB systems in this section, all SPB systems shall meet the behavior requirements of Section 9.6.1 Digital Rights Management.*

##### **9.4.3.6.1. Normative Requirements: Projector Secure Processing Block**

From a security perspective, a projection system consists of the projector Secure Processing Blocks (SPB) type 2 and its companion SPB, which will be either the Link Decryptor Block (LDB) or Image Media Block (IMB).

*The following are the normative requirements for the projector Secure Processing Block (SPB):*

1. *The projector’s companion SPB (Link Decryptor Block or Image Media Block) shall be physically inside of, or otherwise mechanically connected to, the projector Secure Processing Block (SPB).*

- 
2. The projector and Link Decryptor Block (LDB) *Secure Processing Blocks* (SPBs) shall be authenticated to the SM. However, authentication does not ensure that the two SPBs are mechanically connected to each other or ensure that an IMB/projector system is mechanically connected. Therefore, an electronic marriage shall take place upon installation of an IMB or LDB projector pair. This physical/electrical connection shall be battery-backed and monitored 24/7 by the companion SPB and, if broken, shall require a re-installation (re-marriage) process.

*Breaking the marriage shall not zero the projector SPB long term identity keys (RSA private), see item 7 below.*

3. Projector maintenance may involve a marriage (or re-marriage) event, or access to the projector SPB or both. To support projector maintenance, the projector SPB may be serviceable, but access is security-sensitive because of the possibility of tampering during service access.

*Once a projector is installed, projector SPB access door "open", access door "close", "marriage" and "marriage break" events shall be logged, and the "AuthID" token (see Section 9.4.6.3.8 Log Record Information) shall indicate the responsible exhibition party that executed (or supervised) the event(s). Once a projector is installed, all relevant projector SPB events of Section 9.4.6.3 Logging Subsystem shall be logged 24/7 under both powered and un-powered conditions.*

*To avoid the complexity of retaining its own log records (and the associated need for a clock and battery-backed persistence), the projector SPB shall send projector SBP log event data across the marriage electrical interface for retention by the companion SPB.*

4. Projector SPB designs shall not allow physical access to signals running between the companion SPB and the projector SPB without breaking the marriage, in which case a re-installation shall be required and tampering will be observed by the authorized installer (see Section 9.5.2.4 Specific Requirements for Type 2 Secure Processing Blocks).
5. The projector SPB shall accept the decrypted streaming image signal from either the Image Media Block (IMB) or Link Decryptor Block (LDB) SPB and process accordingly.
6. The projector SPB shall provide at least a type 2 image signal path and tamper/access protection container. The physical requirements for a type 2 SPB are given in Section 9.5.2.4 Specific Requirements for Type 2 Secure Processing Blocks.
7. The projector SPB shall include a Secure Silicon host device (see 9.5.2 Robustness and Physical Implementations) which shall contain the SPB's digital certificate.

#### **9.4.3.6.2. Normative Requirements: Link Decryptor Block (LDB)**

*The following requirements are normative where Link Encryption is used:*



- 
1. *As part of the installation (mechanical connection to projector and electrical initiation), perform electrical and logical marriage with the projector SPB. Electrical connection integrity between the Link Decryptor Block and the projector SPB shall be monitored 24/7. Should the integrity of the connection be broken, log the event and require a re-installation process before becoming active again.*

*Breaking of the LDB/projector SPB marriage shall not zero the LDB SPB long-term identity keys (RSA private keys).*

2. *Perform content link decryption, and pass the decrypted streaming image to the appropriate circuitry inside the projector SPB. Link Decryptor Blocks shall be designed so as to not to perform link decryption functions unless married to a projector SPB.*
3. *Respond to the Security Manager's (SM's) initiatives in establishing a Transport Layer Security (TLS) session and Link Decryptor Block authentication. Maintain this session until commanded to terminate.*
4. *Link Decryptor Blocks (LDBs) shall not establish security communications with more than one SM at a time.*
5. *The LDB shall contain a UTC time reference clock which is battery backed and operative for time stamping log events under powered and un-powered conditions. The LDB shall communicate time information with the SM using standardized Intra-Theater Messaging.*
6. *Respond to SM "status" queries, and other Intra-theater Messages (ITMs) and SM commands as necessary to support SM behavior requirements.*
7. *Accept and store link decryption keys, and associated parameters, provided by the SM. The LDB shall have the capacity to store at least 16 key/parameter sets.*
8. *Purge LD keys upon expiration of the SM designated validity period, SM "purge" command, Link Decryptor Block SPB tamper detection, break of projector LDB SPB electrical connection, or change in TLS network parameters suggestive of an attack or equipment substitution.*
9. *Record security event data for logging under both powered and un-powered conditions. Assemble logged information into standardized log records per Section 9.4.6.3 Logging Subsystem. The LDB shall support all logging functions of the projection system by providing 24/7 log recording support and storage of all log records associated with the projection system.*
10. *Monitor Link Decryptor Block SPB physical security protection integrity 24/7. In the event of intrusion or other tamper detection, terminate all activity and zero all Critical Security Parameters (see Section 9.5.2.6 Critical Security Parameters and D-Cinema Security Parameters). Do not purge log records.*

---

#### **9.4.3.6.2.1. Normative Requirements for LD/LE SPB Devices**

*The following requirements are normative where an SPB that performs link decryption followed by link encryption is used (see 9.4.4.1 Special Auditorium Situations):*

- 1. Within the LD/LE Device's type 1 SPB perimeter, perform link decryption followed by link encryption at the image essence input and output ports. Subject to the constraints of Section 9.4.4.1 "Special Auditorium Situations", multiple link encryption output ports may be implemented*
- 2. Respond to the Security Manager's (SM's) initiatives in establishing a Transport Layer Security (TLS) session and SPB device authentication. Maintain this session until commanded to terminate.*
- 3. LD/LE SPB Devices shall not establish security communications with more than one SM at a time.*
- 4. LD/LE SPB Devices shall contain a UTC time reference clock that is battery backed and operative for time stamping log events under powered and un-powered conditions. The SPB shall communicate time information with the SM using standardized Intra-Theater Messaging.*
- 5. Respond to SM "status" queries, and other Intra-Theater Messages (ITMs) and SM commands as necessary to support SM behavior requirements.*
- 6. Accept and store LD/LE keys, and associated parameters, provided by the SM. The SPB shall have the capacity to store at least 16 key/parameter sets.*
- 7. Purge LD/LE keys upon expiration of the SM designated validity period, SM "purge" command, SPB tamper detection, or change in TLS network parameters suggestive of an attack or equipment substitution.*
- 8. Record security event data for logging under both powered and un-powered conditions. Assemble logged information into standardized log records per Section 9.4.6.3 Logging Subsystem.*
- 9. Monitor LD/LE SPB Device physical security protection integrity 24/7. In the event of intrusion or other tamper detection, terminate all activity and zero all Critical Security Parameters (see Section 9.5.2.6). Do not purge log records.*

#### **9.4.3.6.3. Normative Requirements: Image Media Block (IMB)**

*The following are normative requirements for the Image Media Block:*

- 1. Perform all SM functions as defined under Section 9.4.3.5 Functions of the Security Manager (SM).*
- 2. Monitor IMB SPB physical security protection integrity 24/7. In the event of intrusion or other tamper detection, terminate all activity and zero all Critical Security Parameters (see Section 9.5.2.6). If communication with the SMS is available, issue an alert message. Do not purge log records.*

- 
3. *When the IMB is integrated with the projector (i.e., is the projector's companion SPB), at the time of installation (mechanical connection to the projector and electrical initiation) the IMB shall perform and thereafter support electrical and logical marriage with the projector SPB per Section 9.4.3.6.1 Normative Requirements: Projector Secure Processing Block. Electrical connection integrity shall be monitored 24/7, and should the integrity of the connection be broken the IMB shall log the event and require a re-installation process before becoming active again. Breaking of the IMB/projector SPB marriage shall not zero the IMBs long-term identity keys (RSA private keys).*
  4. *Figure 15: Digital Cinema Auditorium Security Implementations of Section 9.4.1 presents the two fundamental security system architectures as auditoriums 1 and 2: an integrated projection system architecture (no link encryption), and a link encryption architecture, respectively. In the first instance the Integrated Media Block (IMB) outputs clear text content. An IMB intended to operate with an integrated projection system shall be designed such that it does not perform any composition decryption functions until integrated and married to a projector SPB. An IMB intended for non- integrated operation shall be designed to not be reconfigurable to operate with an integrated projection system.*
  5. *Perform media decryption for image, audio and subtitle essence. Perform forensic marking for image and audio essence.*
  6. *After image decryption and Forensic Marking (and other non-security plain text functions as appropriate by design), pass the image signal to the projector SPB or link encryption function, as appropriate. In the latter case the image signal shall undergo link encryption per Section 9.4.4 "Link Encryption." Subject to the constraints of Section 9.4.4.1 "Special Auditorium Situations," multiple link encryption output ports may be implemented.*
  7. *Record security event data for logging under both powered and un-powered conditions. Sign and assemble logged information into standardized log records per Section 9.4.6.3 Logging Subsystem. When integrated within a projector as the projector's companion SPB, the IMB shall provide 24/7 log recording support and storage of all log records associated with the projector SPB.*

#### **9.4.3.6.4. Normative Requirements: Audio Media Block**

*Per Section 9.4.2.3 Media Blocks (MBs), audio decryption shall be performed within the Image Media Block (IMB).*

#### **9.4.3.6.5. Projector Authentication**

*Where link encryption is used, authentication of the projection system to the SM is required. The "proxy mode" of authentication is herein defined as the use of the companion LDB and its TLS session to proxy for the projector SPB.*

---

Proxy mode authentication of the projection system is accomplished as follows: LDB certificate information is delivered to the SM during the LDB's TLS session initiation handshake. The projector's certificate information is subsequently delivered to the SM using the GetProjCert Standardized Security Message (see Section 9.4.5.2.4 "Request Response Pairs").

*For married projection systems that use link encryption, projection system authentication shall be according to proxy mode. The SM shall ensure that both the LDB and projector SPB certificate thumbprints are on the TDL prior to enabling playout.*

*When the SM is the companion SPB (i.e., architectures with no link encryption), the projector's certificate information shall be obtained by the SM directly over the marriage connection. The SM shall ensure that the projector certificate thumbprint is on the TDL prior to enabling playout.*

#### **9.4.3.6.6. Permanently Married Implementations**

This section assumes that the LDB and IMB are implemented as field replaceable SPB modules. It is not mandatory, however, that they be implemented in this fashion. It is allowed, for example, for the LDB to be permanently married to a projector, and not field replaceable. In such a case where the projector and its companion SPB (LDB or IMB) are not field separable, there is no marriage event, and thus no reason to monitor whether the marriage connection is broken. This relieves the companion SPB from marriage monitoring duties, but does not change the requirement for IMB or LDB equivalent SPB functions, and the projector SPB, to meet the respective SPB type 1 and type 2 physical and logical protection requirements of Section 9.5 Implementation Requirements, and the normative requirements as specified above, except as the latter requirements relate to marriage event and connection monitoring.

*In the case where the Projector and companion SPB are inseparable, a single Digital Cinema Certificate shall represent both the Projector and its companion SPB (Image Media Block or Link Decryptor Block). For dual certificate implementations this shall be the Security Manager Certificate (see Section 9.5.1 Digital Certificates).*

*Implementations that do not meet the marriage functions, per the normative requirements of this section, shall not permit field replacement of the IMB or LDB security function as appropriate according to which function is the companion SPB to the projector, and shall require the projector SPB and companion SPB system to be replaced in the event of an SPB failure.*

*A deviation from these requirements shall be considered non-compliant and a "Security Function Failure" (see Section 9.5.5 Compliance Testing).*

Note: For permanently married implementations where there are no remote SPBs the KDM need not carry Trusted Device List (TDL) information. The KDM syntax requirement that the associated "DeviceList" element not be empty can be satisfied by placing any Digital Cinema certificate thumbprint in this field.

---

#### 9.4.3.7. Theater System Clocks and Trustable Date-Time

*Note: Nothing in this section shall require that the user interfaces of the SMS or TMS use UTC. It is envisioned that these will use local time.*

*To ensure playback times and event log time stamps are time-accurate, means must exist to distribute and maintain proper security system time. Time shall mean UTC (Coordinated Universal Time). See ASN.1 standard syntax for transferring time and date data "GeneralizedTime" and "UTCTime".*

- *All security transactions conferring date-time information (e.g., KDM time window) shall be UTC.*

*Security Managers shall each be responsible for maintaining secure and trusted time for the auditorium to which they are assigned (installed). The security system clock requirements are:*

- *The Image Media Block (IMB) SM shall be responsible for establishing and maintaining time for the auditorium equipment suite it supervises.*
- *Each Image Media Block (IMB) SM clock shall be set by the SM vendor to within one second of UTC using a reference time standard (such as WWV). The clock shall be tamper-proof and thereafter may not be offset from UTC or otherwise reset.<sup>14</sup>*
- *In order to maintain synchronism between auditoriums, Exhibition shall be able to adjust a Security Manager's time a maximum of +/- six minutes within any calendar year. Time adjustments shall be logged events.*
- *Remote SPBs type 1 shall have internal UTC time clocks, and maintain time-awareness 24/7 under both powered and un-powered conditions. The Security Manager shall track the time difference between remote SPB clocks and its internal clock by issuance of the "GetTime" standardized security message of Table 15 "Intra-Theater Message Request-Response Pairs" at least once per day.*
- *The IMB Security Manager (SM) clock shall have the following capabilities:*
  - *Resolution to one second*
  - *Stability to be accurate +/- 30 seconds/month*
  - *Date-Time range at least 20 years*
  - *Battery life of at least 5 years*
  - *Battery can be changed without losing track of proper time*
  - *Proper time stamping of log events shall not be interrupted during a clock battery change process.*
- *Remote SPB clocks shall meet the same capabilities as the SM clock, except the stability requirements are +/- 60 seconds per month. Exhibition shall be able to adjust a remote SPB's time a maximum of +/- fifteen minutes within any calendar*

---

<sup>14</sup> A limited-magnitude adjustable time offset to this clock is described in the subsequent point.

---

*year. Time adjustments shall be logged events.*

#### **9.4.4. Link Encryption**

*Link Encryption shall be used at all times (i.e., for encrypted and clear text content) where image content is carried on interconnecting cables, which are exposed (i.e., outside of an SPB) downstream from image media decryption. The Security Manager (SM) shall enforce link encryption operations per the requirements of this section in all applications except for fully integrated architectures (i.e., "Auditorium 1" configuration of Figure 15: Digital Cinema Auditorium Security Implementations).*

*Where Link Encryption is used (i.e., Auditorium 2 Figure 15: Digital Cinema Auditorium Security Implementations), the Image Media Block (IMB) SM shall provide link encryption keys for use with the Link Encryptor (LE) and Link Decryptor (LD) Security Entities (SE) located within the IMB and Link Decryptor Block (LDB) SPBs respectively. Authentication of the LDB by the IMB SM (see Security Manager and LDB requirements of Section 9.4.3.5 Functions of the Security Manager (SM) and Section 9.4.3.6.2.1 Normative Requirements for LD/LE SPB Devices) shall be performed to ensure that link keys are provided only to legitimate devices which appear on the KDM Trusted Device List (see Section 9.6.2 "Trust" and the Trusted Device List (TDL)). Link Encryption keys shall be delivered to the LDB using the appropriate category 2 standardized security messages of Table 15 Intra-Theater Messages Request-Response Pairs.*

*In the case of playback of clear text content (as indicated by the CPL), no KDM is required, and in such a case no TDL will exist. Recognizing that combinations of clear text and encrypted content must be accommodated, the following rules define normative Link Encryption functionality:*

- In any instance where content is not encrypted and no KDM for this content exists, the SM shall automatically assume "trust" in the LDB and projector SPBs for purposes of keying the LDB and enabling playback for (only) that CPL. All logging processes shall take place normally, recognizing that some logging events (e.g., no logging of content key use) will not be recorded.*
- In instances where combinations of encrypted and non-encrypted content constitute a Show Playlist, the SM shall require the LDB and projector to appear on the TDL prior to enabling keying Link Encryption functions and enabling playback for any CPL having encrypted content.*

*Link Encryption shall be implemented according to RDD 20-2010 SMPTE Registered Disclosure Document: "CineLink 2 Specification." Link Encryption keys shall be generated according to the requirements of Section 9.7.6 Key Generation and Derivation. Link Encryption keys shall be distributed using the appropriate Standardized Security Messages of 9.4.5.2.4 Request-Response Pairs (and shall not be distributed using in-band techniques). The individual requirements of this specification shall take precedence over RDD 20-2010 as a whole.*

*It is mandatory that a fresh Link Encryption key be used for each movie showing (i.e., each playout of an encrypted composition requires a new LE key.) Multiple Link Encryption keys may be used for showings, and in such cases, it is encouraged that different LE keys be distinguished by (used according to) the CPL (where different Composition Playlists constitute a showing). In the case*

---

where multiple LE keys are used, it will be necessary for the industry to standardize on a single technique to identify which LE key is to be used for which portion(s) of any given showing.

#### **9.4.4.1. Special Auditorium Situations**

“Special Auditorium Situations” are defined to allow the Image Media Block (IMB) to operate with more than a single projector. *Special Auditorium Situations shall be enabled by the following methods:*

- IMB with Multiple Link Encryption means the use of (i) more than one remote LDB/projector pair with a single IMB, or (ii) an LD/LE image processor SPB inserted between the IMB and one or more remote LDB/projector pair(s).
- Integrated IMB with Link Encryption means the use of an integrated and married IMB/projector pair, where the IMB also outputs a Link Encrypted image signal to one or more remote LDB/projector pair(s). *The IMB shall simultaneously meet all requirements for both integrated and non-integrated projector system implementations.*

*SMs shall enable Special Auditorium Situations to operate only when the SM receives a KDM whose Trusted Device List (TDL) contains only the identities of the SPBs it is enabling for playback. For IMB with Multiple Link Encryption operation these shall be the remote SPBs identified during TLS authentication (see details below). For Integrated IMB with Link Encryption this additionally includes the identity of the projector to which the IMB is married. This matching is an indication to the SM that Special Auditorium Situations operation has been approved by the content owner.*

*IMB with Multiple Link Encryption operation or Integrated IMB with Link Encryption operation shall follow all normal (single) Link Encryption requirements of this section, with the following additional requirements:*

- a. *SM behavior shall be designed to identify a Special Auditorium Situation during the auditorium security network TLS session establishment. The digital certificate exchange with remote SPBs shall return the associated certificate roles for each SPB in the auditorium.*
- b. *The SM shall independently authenticate each remote SPB against the TDL using a dedicated TLS session.*
- c. *The SM shall independently key each remote SPB for Link Encryption operation using standardized Intra-Theater (security) Messaging per Section 9.4.5.*
- d. *The SM shall not support the use of more than one LD/LE image processor SPB for any given projector.*
- e. *The Link Encryption stages of the LD/LE image processor configuration may use the same LE key(s). Similarly, the SM may key the multiple LDB/projector configuration using the same LE key for each LDB/projector system.*

---

## 9.4.5. Intra-Theater Communications

This Section discusses requirements for communications necessary to support security functions in each auditorium. Depending upon facility communications network designs, there may be both intra-auditorium as well as theater-wide networks and these may be physically one network. The security system requires and addresses only the intra-auditorium network, over which Intra-Theater (security) Messages (ITM) are employed.

Intra-Theater Message(s) (ITMs) are described for communications between the SMS and SM, and between the SM and remote Secure Processing Blocks (SPBs). Note that, depending upon SPB designs, the numbers of SPBs used, and the mix of Security Entities (SEs) within them may vary.

### 9.4.5.1. Transport Layer Security Sessions, End Points and Intra-Theater Messaging

*The SM and SMS shall both conduct their intra-theater security messaging under TLS protection (IETF RFC 2246).*

*All TLS end points shall be within the physical protection perimeter of the associated SPB. No SPB requirements are placed on the SMS.*

### 9.4.5.2. Intra-Theater Message Definitions

This section identifies the set of Intra-Theater Messages standardized by this specification. *These are required to support interoperability and normative operational and security behavior of SPB systems.*

#### 9.4.5.2.1. Intra-theater Message Hierarchy

The following hierarchy for Intra-Theater Messaging (ITM) is defined:

- Transactions – Describe the interactions between exhibition components (Security Entities) and the system state changes that occur as a result of the transaction.
- Request/Response Pairs (RRP) – Describes a single interaction between the SEs. *At least one RRP is required to implement a transaction.*
- Messages – A data structure that passes between SEs. An RRP consists of a request message and a resultant response message.

A transaction consists of sequences of RRP, and RRP are pairings of messages. A transaction is an interaction, or series of interactions (RRP) that change the state in one or more participating SEs in a consistent manner. Transactions need not be standardized. In assembling transactions, the sequences of RRP used may vary according to the equipment vendor or facility configuration. *Transactions shall be “idempotent” (such a transaction may be repeated without changing its outcome).* Thus, if the initiator of a transaction does not receive evidence of satisfactory completion, it may safely initiate the transaction again without fear of unexpected consequences.

RRP standards do not apply inside of Secure Processing Blocks (SPBs), however RRP concepts are developed assuming that a Security Entity (SE) will exist logically within a SPB,



---

even if not distinctly in hardware. *The SPB is allowed to proxy for any SE (within it) in the support of security messaging.*

#### **9.4.5.2.2. Terms and Abbreviations**

The following abbreviations and terms are used in this ITM section:

- Requester = initiator of an RRP
- Responder = answers the RRP
- UDP & TCP = IP protocols for delivering blocks of bytes (UDP) or stream of bytes (TCP)

#### **9.4.5.2.3. General RRP Requirements**

1. *Only the SMS or SM shall set up Transport Layer Security (TLS) sessions. TLS session establishment between SMS and SM may be initiated by either party. Except where noted, only the SMS or SM shall initiate RRRPs.*
2. *Security Managers (SMs) shall not communicate with SPBs other than those in its suite, and SPBs shall not communicate with SMs other than the one assigned to their suite.*
3. *During normal operations, Secure Processing Blocks (SPBs) shall maintain their TLS communications sessions with the SM open and active at all times.*
4. *Absence of a response after an RRP is directed to a SPB over an active TLS session represents a network failure or SPB fault condition. Playback shall continue under network failure conditions to the extent possible.*
5. *Unless otherwise noted, an RRP response is allowed to be busy or an unsupported message type, and such a response shall not be an error event.*
6. *No broadcast RRP commands shall be used or required.*
7. *Except where noted, non-TLS security communications shall not be allowed, and production Digital Cinema security equipment shall have no provisions for performing security functions in a TLS “bypass” mode.*
8. *RRP protocols shall be synchronous: Each pairing shall be opened and closed before a new RRP is opened between any two devices. Nested transactions (in which one end point must communicate with another end point while the first waits) are allowed.*
9. *Standardized security messages (Category 2 messages of Table 15) shall use, and have exclusive use of, well-known port 1173 (which has been reserved for SMPTE digital cinema use by the Internet Assigned Numbers Authority [IANA]). Operational messages (Category 1 messages of Table 15) shall not use well-known port 1173, but shall operate under TLS.*

---

10. Equipment suppliers may implement proprietary ITM, however such ITM shall not communicate over well-known port 1173 (i.e., any non-standardized ITM shall use a different port).

11. Equipment suppliers shall define and describe their respective security designs surrounding the use of well-known port 1173 per the requirements of FIPS 140-2 per Section 9.5.2.5 FIPS 140-2 Requirements for Type 1 Secure Processing Blocks.

#### 9.4.5.2.4. Request-Response Pairs (RRP)

Table 15: Intra-theater Message (ITM) Request-Response Pairs (RRP) lists "standardized security messages" (category 2) and suggested "operational messages" (category 1). The following establishes the implementation requirements for these message types:

- **Standardized Security Messages** - Standardized security messages shall be compliant to SMPTE 430-6 D-Cinema Operations - Auditorium Security Messages, and shall consist only of messages listed as category 2 messages of Table 15: Intra-theater Message (ITM) Request-Response Pairs (RRP). These messages are used between the Image Media Block and remote SPBs, with the IMB as the Requestor (RRP initiator). The security data and related information that is the subject of these messages shall be communicated only via standardized security messages.
- **Operational Messages** - The implementation of operational messages is not normatively specified. However, to support log event recording (see 9.4.6.3 Logging Subsystem), it shall be mandatory that Security Managers functionally support Table 15: Intra-theater Message (**ITM**) Request-Response Pairs (RRP) category 1 operational messages. This means that the SM must be capable of performing the function, whether via ITM command, or other control means. The functional approach shall specify an "AuthorityID", which is intended to indicate the SMS operator, per Section 9.4.2.5 Screen Management System (SMS).

The term "Auditorium Security Messages" (ASMs) in SMPTE 430-6 corresponds to the term "standardized security messages" in this specification. The combination of the terms "standardized security messages" and "operational messages" are referred to in this specification as Intra-Theater Messages (ITMs).

Message Category	Function
<b>1. SMS to SM</b> StartSuite StopSuite CPLValidate KDMValidate TimeAdj	<b><i>Suggested operational messages</i></b> Commands SM to establish TLS sessions with remote SPBs Commands SM to terminate TLS sessions with remote SPBs Requests that the SM perform a CPL validation check Requests that the SM perform a KDM validation check Adjusts time at SM (within annual limits)
<b>2. IMB SM to SPB</b> BadRequest GetTime GetEventList GetEventID QuerySPB LEKeyLoad LEKeyQueryID LEKeyQueryAll LEKeyPurgeID LEKeyPurgeAll GetProjCert	<b><i>Standardized security messages</i></b> Special "Response" indicating failure to process a "Request" Requests a snapshot of a remote SPBs absolute (UTC) time Requests a list of logged event IDs for a specified time window Requests the return of a specified logged event by ID Interrogates a remote SPB as to health and status Delivers one or more LE keys to a Link Decryptor Block (LDB) Interrogates the LDB for the presence of a specified LE key Requests a report of all active LE keys by key ID Commands the LDB to purge a specified LE key Commands the LDB to purge all active LE keys Requests the LDB to deliver a copy of the projector certificate

**Table 15: Intra-theater Message (ITM) Request-Response Pairs (RRP)**

### 9.4.5.3. Intra-Theater Message Details

This section provides particular requirements for specific messages.

#### 9.4.5.3.1. Screen Management System to Security Manager Messages

[This section left blank intentionally.]

#### 9.4.5.3.2. Image Media Block Security Messaging

*Image Media Block to remote SPB messages are category 2 Intra-Theater Messages of Table 15: Intra-theater Message (ITM) Request-Response Pairs (RRP). Standardized security messages are defined in SMPTE 430-6 D-Cinema Operations - Auditorium Security Messages. The following requirements are in addition to those in SMPTE 430-6:*

- *SPB security devices shall be designed to meet the round trip latency requirements suggested in SMPTE 430-6.*
- *A remote SPB shall respond to the QuerySPB command (i.e., the "ResponderBusy" general response element code "3" is not permitted). To meet this requirement, vendors are encouraged to assure that adequate message processing periods exist between this and other RRP command types.*
- *The following QuerySPB "security alert" conditions are defined, and shall be reported per status code "2" of this command's response:*

1. SPB perimeter open (e.g., service access door).
  2. Marriage broken event detected (see Section 9.4.3.6.1. Normative Requirements: Projector Secure Processing Block).
  3. Conditions that require replacement of the SPB (i.e., equipment tampering or failure) per Section 9.6.1.3. Digital Rights Management: Security Entity (SE) Equipment.
- The LEKeyLoad command “expire time” shall be 6 hours per Section 9.4.3.5. Functions of the Security Manager (SM), Item 9.b.
  - When performing TLS 1.0 handshake mutual authentication, it shall be permissible for the TLS client and server devices to deliver only the respective SPB device leaf certificate.
  - For mutual authentication during TLS session establishment in dual certificate Image Media Block (IMB) implementations (see Section 9.5.1.2 Dual Certificate Implementations) the SM shall present IMB certificates as follows:
    1. SM establishes the TLS session with a remote SPB (SM is the “TLS client”) - The Log Signer Certificate (LS Cert) shall be presented.
    2. SMS establishes the TLS session with SM (SM is the “TLS server”) - The SM Certificate (SM Cert) shall be presented.
  - The GetProjCert RRP command of Table 15 shall be implemented as follows:

#### **GetProjCert Command**

The GetProjCert command returns the projector SPB certificate from the Link Decryptor Block (LDB) over the LDB’s TLS connection with the Security Manager. *The certificate returned shall be from the projector (SPB) to which the LDB is currently married. This command shall fail if the LDB is not in an actively married state.* (The references to SMPTE 430-6 are informative.)

#### **GetProjCert Request**

Item Name	Type	Length	UL	Description
GetProjCert Request	Pack Key	16		Identifies the GetProjCert Request *
Request Length	BER Length	4		Pack Length
Request ID	UInt32	4		ID of this request

\* Bytes 12 and 13 shall be 02 and 18. (See SMPTE 430-6, Tables A-1, A-2)

### GetProjCert Response

Item Name	Type	Length	UL	Description
GetProjCert Response	Pack Key	16		Identifies GetProjCert Response *
Response Length	BER Length	4		Pack Length
Request ID	Uint32	4		ID of the request for which this is the response
Projector Certificate Data	Byte Array	Variable		DER encoded certificate
Response	Uint8	1		Response Info **

The length of the certificate is determined from the length of the response.

\* Bytes 12 and 13 shall be 02 and 19. (See SMPTE 430-6, Tables A-1, A-2)

\*\* Response (see SMPTE 430-6 Section 6.3):

0 - RRP successful

1 - RRP failed

2 - RRP Invalid

3 - ResponderBusy

**Table 16:** Left Intentionally Blank

**Table 17:** Left Intentionally Blank

**Table 18:** Left Intentionally Blank

### 9.4.6. Forensics

Forensics do not prevent content theft or other compromises, but rather, it provides methods for their detection and investigation. Forensic features deter attackers who are aware that their actions would be logged and/or reported in considerable detail.

Forensic features fall into two classes: Forensic Marking (FM) and logging. Forensic Marking embeds tracking information into content itself, to be carried into subsequent legitimate or stolen copies. Logging creates records of both normal and abnormal events in the Distribution and Exhibition process. During a content theft investigation, both FM and logging information may be combined to establish the details of the security compromise.

Industry terminology for watermarking and Forensic Marking is not consistent. For these security specification purposes, stakeholders have agreed to use the term Forensic Marking for all content marks.

---

#### **9.4.6.1. Forensic Marking**

*These specifications require that image and audio Forensic Marking (FM) capability be included in each Image Media Block. The security system identifies content marking devices (e.g., Forensic Marking embedders) as the “FM” Security Entity (SE) type. To support FM processes, standardized Intra-Theater Messaging (ITM) may be used where needed for communications between such SEs and Security Managers (SMs). Such communications and associated FM behavior is outside of this specification. However the requirements of ITM Section 9.4.5 Intra-Theater Communications shall be mandatory where such theater messaging employs the intra-auditorium security network. Forensic Marking does not require interoperability between detection systems, as the detection operation is usually performed “off line” as part of a security investigation.*

Multiple solutions may be qualified and will allow Media Block solutions providers to select the solution of their choice. Candidate providers should meet with individual studios to discuss RAND and technical suitability of their approach.

Note: DCI reserves the right, at some future time, to require a specific Forensic Marking insertion solution for Digital Cinema systems.

*At a minimum, Forensic Marking systems are required to meet the following:*

##### **9.4.6.1.1. General Requirements**

- *The Forensic Marking data payload is required to be a minimum of 35 bits and must contain the following information:*
  - *Time stamp every 15 minutes (four per hour), 24 hours per day, 366 days/year the stamp will repeat annually. There are 35,136 time stamps needed, therefore allocate a 16 bit unsigned number (65,536).*
  - *Location (serial number) information, allocated 19 bits (524,000 possible locations/serial numbers)*
- *All 35-bits are required to be included in each five minute segment.*
- *Forensic Marking insertion is required to be a real-time (i.e., show playback time), in-line process performed in the associated media block, and is required to have a reasonable computational process.*
- *Recovery can take up to a 30-minute content sample for positive identification.*
- *Support of a single distribution inventory is required.*
- *Terms and conditions of use are required to be reasonable and non-discriminatory (RAND).*
- *Detection can be performed by the vendor or the Rights Owner at the Rights Owner’s premises.*
- *DCI will entertain development of a generic Forensic Mark inserter architecture. Any FM technology utilizing pre-processing is required to use a generic inserter*

---

architecture that meets the criteria outlined below. Additionally, a full understanding of the intellectual property terms and conditions will need to be reached.

- *Standardized Metadata Format* – Any pre-processing solution is required to be able to utilize a single, industry standardized metadata transport format and a generic inserter solution.
- *Title (Composition) Single Inventory* – For each composition, the system is required to support the use of a single image or audio FM technology that generates one set of metadata. This metadata is required to be compatible with all deployed compliant generic inserters. At the distributor’s discretion, multiple sets of metadata can be used to mark the same composition.
- *Generic Inserter Compatibility* – For the initial generic inserter deployment, the generic inserter in final product form is required to be openly demonstrated and independently tested to demonstrate compatibility with a minimum of three independent metadata-based forensic marking solutions.
- *Forensic Mark and Generic Inserter Backwards Compatibility* – After initial deployment, any subsequent metadata-based FM solutions or generic inserters are required to function correctly with all deployed compliant systems.
- *Forensic Mark Pre-Processing Speed* – The Forensic Mark processing steps needed to generate and insert metadata are required to be real time or faster and are required to occur in a single pass.
- *As a matter of implementation, recognizing business and post-production constraints, it is encouraged that a generic inserter implementation minimizes the metadata payload needed to provide forensic mark data to the generic inserter. A reasonable target would be less than two percent of the compressed image and sound data payload.*
- *Forensic Marking shall be permanently associated with the Image Media Block that contains it. To enforce this association, the following requirements are mandatory:*
  - *Each instance of a Forensic Marking application shall be assigned a unique Forensic Marking Identification (FMID).*
  - *Forensic Marking shall be manufactured such that the FMID cannot be changed or reprogrammed by any means whatsoever without violation of the IMB’s SPB-1 perimeter.*
  - *Manufacturers of Image Media Blocks shall maintain and make available an accurate, timely database associating each FMID with its associated IMB serial number and IMB digital certificate.*
  - *Forensic Marking licensors shall insure the uniqueness of FMIDs.*

---

#### **9.4.6.1.2. Image/Picture Survivability Requirements**

- *Image Forensic Marking is required to be visually transparent to the critical viewer in butterfly tests for motion image content.*
- *Is required to survive video processing attacks, such as digital-to-analog-digital conversions (including multiple D-A/A-D conversions), re-sampling and re-quantization (including dithering and recompression) and common signal enhancements to image contrast and color.*
- *Is required to survive attacks, including resizing, letterboxing, aperture control, low-pass filtering and anti-aliasing, brick wall filtering, digital video noise reduction filtering, frame-swapping, compression, scaling, cropping, overwriting, the addition of noise and other transformations.*
- *Is required to survive collusion, the combining of multiple videos in the attempt to make a different fingerprint or to remove it.*
- *Is required to survive format conversion, the changing of frequencies and spatial resolution among, for example, NTSC, PAL and SECAM, into another and vice versa.*
- *Is required to survive horizontal and vertical shifting.*
- *Is required to survive arbitrary scaling (aspect ratio is not necessarily constant).*
- *Is required to survive camcorder capture and low bit rate compression (e.g. 500 Kbps H264, 1.1 Mbps MPEG-1).*

#### **9.4.6.1.3. Audio Survivability Requirements**

- *Audio Forensic Mark is required be inaudible in critical listening A/B tests.*
- *The embedded signal is required to survive multiple Digital/Analog and Analog/Digital conversions.*
- *Is required to survive radio frequency or infrared transmissions within the theater.*
- *Is required to survive any combination of captured channels.*
- *Is required to survive resampling and down conversion of channels.*
- *Is required to survive time compression/expansion with pitch shift and pitch preserved.*
- *Is required to survive linear speed changes within 10% and pitch-invariant time scaling within 4%.*
- *Is required to survive data reduction coding.*
- *Is required to survive nonlinear amplitude compression.*
- *Is required to survive additive or multiplicative noise.*
- *Is required to survive frequency response distortion such as equalization.*
- *Is required to survive addition of echo.*



- *Is required to survive band-pass filtering.*
- *Is required to survive flutter and wow.*
- *Is required to survive overdubbing.*

#### **9.4.6.2. Forensic Marking Operations**

There may be differing circumstances surrounding the desire by a Rights Owner to forensically mark content. To accommodate these variations, it is necessary to be able to independently control the activation of both the audio and the image Forensic Marking (FM). *The following rules shall be normative for Forensic Marking operations:*

1. *The SM shall be solely responsible for control of FM marking processes (i.e., "on/off") for the auditorium it is installed in, and, subject to item 2 below, command and control of this function shall be only via the KDM per item 3 below.*
2. *Forensic Marking shall not be applied to non-encrypted audio or image content. If portions of a composition are encrypted and other portions are not, FM shall not be applied to those Track Files that are not encrypted.*
3. *Forensic Marking shall otherwise be applied to all encrypted picture and audio content, except as follows:*
  - a. *The "no FM mark" and "selective audio FM mark" state shall be commanded by the 'ForensicMarkFlagList' element of the KDM.*
  - b. *When the KDM 'ForensicMarkFlagList' indicates the "no FM mark" command, the FM device(s) shall enter a full bypass mode, and shall not alter the content essence for the associated encrypted DCP.*
  - c. *When the KDM 'ForensicMarkFlagList' indicates the "selective audio FM mark" command, the audio FM device(s) shall not impose, in the associated encrypted DCP, any mark onto audio channels above the channel indicated in the command, per (d) below. This paragraph shall override (b) above if both the "no FM mark" and "selective audio FM mark" commands are present.*
  - d. *The "selective audio FM mark" command shall be indicated by the presence of a ForensicMarkFlag element containing a URI of the form:*  
*<http://www.dci-movies.com/430-1/2006/KDM#mrkflg-audio-disable-above-channel-XX> where XX is a value in the set {01, 02, 03, 04, 05, 06, 07, 08, 09, 10, 11, 12, 13, 14, 15, 16 ... 99} and corresponds to a channel identifier within the track, per 382M-2007 table E.1, as wrapped in a Sound Track file of the associated encrypted DCP. URIs of this form shall be used in conjunction with keys of KeyType "MDAK". A KDM shall carry only one such ForensicMarkFlag element.*
4. *"No FM mark" states shall be capable of being independently commanded for audio or image compositions.*

- 
5. *When commanded, the “no FM mark” state shall apply to the entire encrypted DCP. The “no FM mark” state shall not apply to any other DCP, even if the other DCP is part of the same showing (i.e., same Show Playlist).*
  6. *[This item left blank intentionally.]*
  7. *SM control of the Forensic Marking “no FM mark” state in remote SPBs shall be communicated via a Table 15 category 2 standardized security Intra-Theater Message (see Section 9.4.5. Intra-Theater Communications).*
  8. *The SM and FM Security Entities shall log the presence or absence of audio and image Forensic Marking for each encrypted DCP.*
  9. *Notwithstanding the exceptions defined in Section 9.4.6.2, all audio essence shall be forensically marked, up to sixteen channels.*

### **9.4.6.3. Logging Subsystem**

In the Exhibition environment, the preparations for and execution of a movie showing creates information that has security and forensic implications. The capturing and storage of such information is the responsibility of the logging subsystem. In order to realize a “control lightly/audit tightly” end-to-end security environment, the security system includes a secure logging subsystem.

Cryptographic technology as applied to essence and key delivery, together with agreed upon usage rules provides the “control lightly” characteristics. The function of a logging subsystem is to respond to the “audit tightly” requirement. Logging is therefore observed as a critical component of security, and secure logging information and surrounding processes are subject to the same fundamental cryptographic requirements as the front end control components: cryptographic protection of critical functions and data components related to integrity, data loss, confidentiality and movement.

This section sets the logging subsystem requirements for security log data recording and reporting. *The log information data formats and structures to be used in conjunction with these requirements are defined in two SMPTE standards:*

- *SMPTE 430-4 D-Cinema Operations - Log Record Format Specification for D-Cinema*
- *SMPTE 430-5 D-Cinema Operations - Security Log Event Class and Constraints for D-Cinema*

SMPTE 430-4 defines the general format for log classes for digital cinema. SMPTE 430-5 defines the specific requirements for the security log class. *All log requirements and terminology of this section are with respect to the SMPTE 430-5 security events class constraints specification.*

Definitions related to logging:

- **Log Event** – Any event that has security implications or forensic value. Such an event results in the recording of log data.
- **Log Data** – Security event information that is recorded and stored within the Security Entity (SE), where such an event took place or was observed.

- 
- Log Record – Standardized XML structure representing a discrete logged event.
  - Log Report – Standardized XML structure containing one or more log records spanning a continuous sequence in time. The log record content in a report is intended to be organized by class, and may be filtered prior to delivery according to specified criteria (Rights Owner, CPL, etc.).

Following the above definitions, a basic logging process is described:

- Surrounding a showing will be a number of security events that result in logged data. *Discrete logged event data shall be placed in an XML structure called a record.*
- A number of records are collected in sequence and by class to make up log reports.
- A complete (unfiltered) report is useful for transferring entire sets of log data for archiving or post-processing outside of the security system.
- A “filtered” report is useful for responding to a request for log data according to specified bounds (e.g., report the SE key usage records for CPL(id) for specific date(s) and time(s)).
- Reports may be delivered via the theater network using log messages (Intra-theater Messages), or simply transferred to a physical device (e.g., USB removable flash memory).

#### **9.4.6.3.1. Logging Requirements**

1. *Logging subsystem implementations shall not affect the ability of Exhibition to operate their projection systems in a standalone fashion.*
2. *Security Entities (SE) shall have normative requirements for the specific log data to be recorded for each record (see Section 9.4.6.3.7 Security Log Reports and Section 9.4.6.3.8).*
3. *Log records and reports shall be protected from undetected alteration (integrity and authentication) or deletion (continuity).*
4. *Log records and reports shall be non-repudiable and traceable back to the source SE device (i.e., where the logged event took place).*
5. *Log records and reports shall carry proof of authenticity, which does not rely on the trustworthiness of the systems and channels they pass through. Systems or devices which communicate, handle or store log messages (or records) need not be trusted or secure.*
6. *The content of log records shall be protected from exposure to parties other than the intended recipient (see Section 9.4.6.3.6 Log Filtering).*
7. *Each Rights Owner shall be able to cryptographically confirm the integrity and continuity of log records and their log data independently of other Rights Owners (see Section 9.4.6.3.6 Log Filtering).*

- 
8. *Image Media Block SMs shall collect log information from all remote Secure Processing Blocks in the suite it enables at the earliest equipment idle time between scheduled showings. To assure timely collection, TLS sessions shall not be terminated prior to collection of all remote SPB log data, and in no event shall more than 24 hours pass between the recording of log data by a remote SPB and the collection of such data by the IMB Security Manager.*
  9. *The Image Media Block shall internally store at least twelve (12) months of typical log data accumulation for the auditorium in which it is installed, including log data collected from the associated remote SPBs.*
  10. *Remote Secure Processing Blocks (SPBs) shall have sufficient secure storage to hold log data to accommodate at least two days' worth of typical operation.*
  11. *Log records stored in SPBs shall be stored in non-volatile memory and not be purgeable. Data shall be over-written beginning with the oldest data as new log data is accumulated. In no event shall remote SPB log records be overwritten prior to them being collected by the SM.*
  12. *An SE shall author its own log records, or utilize the services of a proxy within the same secure SPB.*
  13. *SEs or their SPB proxy shall have an asymmetric identity key pair and Digital Cinema certificate for signing log records. Log records shall be signed only by a Security Manager (SM).*
  14. *SEs or their proxy shall time stamp log records, with date/time synchronized with the auditorium SM's secure clock. The accuracy of the time stamp relative to the actual event shall not exceed one (1) second. Accuracy shall mean the latency between the occurrence of the event and the indicated time stamp.*
  15. *SEs or their proxy shall sequence log records with a secure and persistent counter.*
  16. *An Image Media Block Security Manager (SM) shall associate (identify) all suite log records with the SMS under which it operates.*
  17. *Any use of a proxy in the above, shall produce log records compliant to these requirements.*

#### **9.4.6.3.2. Log Record and Report Format**

*Log record and report formats shall be compliant with SMPTE 430-5 D-Cinema Operations – Security Log Event Class and Constraints for D-Cinema.*

#### **9.4.6.3.3. Log Signatures and Integrity Controls**

*Log signatures and integrity controls shall be compliant with SMPTE 430-5 D-Cinema Operations - Security Log Event Class and Constraints for D-Cinema.*

---

For dual certificate Image Media Block (IMB) implementations (see Section 9.5.1.2 Dual Certificate Implementations), the following requirements are in addition to those in SMPTE 430-5:

- The LogReport element shall contain the reportingDevice child element as defined in SMPTE 430-4 "D-Cinema Operations - Log Record Format Specification". The reportingDevice element shall be completed as follows (see SMPTE 433 "D-Cinema - XML Data Types"): In the case that the DeviceIdentifier element contains a UUID, the DeviceCertID element shall also be present and shall contain the certificate thumbprint of the SM Certificate. In the case that the DeviceIdentifier element is a certificate thumbprint, it shall contain the certificate thumbprint of the SM Certificate. In either case the certificate thumbprint of the Log Signer Certificate shall be present in the AdditionalID element, encoded as an XML Schema *ds:DigestValueType* type.
- Log records shall be signed per the requirements of SMPTE 430-5 section 6.2 "Log Record Authentication and Chaining" using the device's Log Signer Certificate.

#### **9.4.6.3.4. Security of Log Record Sequencing**

Log record sequencing shall be compliant with SMPTE 430-5 D-Cinema Operations - Security Log Event Class and Constraints for D-Cinema.

#### **9.4.6.3.5. Log Upload Protocol over Theater Networks**

Auditorium suites using Link Encryption shall transfer log records from remote Secure Processing Blocks (SPB) to that auditorium's Image Media Block (IMB) SM using the GetEventList and GetEventID standardized security messages of Table 15 "Intra-Theater Message Request-Response Pairs"

Per Section 9.4.3.7 Theater System Clocks and Trustable Date-Time, the Security Manager collects UTC time-stamped reports from remote SPBs via the GetTime standardized security message. The SM shall use the GetTime information to calculate the difference between true time (the SM's time) and time in the remote SPB, and remove the difference in reporting remote SPB event data. The reporting (export) of log information from the IMB shall be by XML structure that is compliant with SMPTE 430-5 D-Cinema Operations - Security Log Event Class and Constraints for D-Cinema.

#### **9.4.6.3.6. Log Filtering**

Log record and/or report filtering processes shall be compliant with SMPTE 430-5 D-Cinema Operations - Security Log Event Class and Constraints for D-Cinema.

For distribution of log information, it may be necessary to filter log content so that log records or reports can be generated that supply log record content selectively to the appropriate recipients. The location(s) where log data filtering takes place (e.g., in the Image

---

Media Block (IMB) or in external theater-controlled devices or processes) is an implementation decision.

#### **9.4.6.3.7. Security Log Reports**

*The Image Media Block (IMB) SM shall provide (export) log event information in the form of log reports (not log records) as defined in SMPTE 430-5 D-Cinema Operation - Security Log Event Class and Constraints for D-Cinema.*

*The EventID (see SMPTE 430-4 D-Cinema Operations - Log Record Format Specifications) shall be a single, invariant value that uniquely identifies each logged event. For avoidance of doubt, for a given event the EventID shall be the same value each time it appears in a log report.*

#### **9.4.6.3.8. Log Record Information**

*The logging subsystem shall follow the requirements for specific log data to be recorded as defined in SMPTE 430-5 D-Cinema Operations - Security Log Event Class and Constraints for D-Cinema. SMPTE 430-5 defines the following data types for the "Security Class" category of log information:*

EventType - Identifies a log record as being associated with one of a Payout, Validation, Key, ASM or Operations event.

EventSubType - Specifies what information is to be logged for each Event Sub Type record.

*Each Secure Processing Block (SPB) type shall log the Event Sub Type records as shown in Table 19 Security Log Event Types and Subtypes.*

	IMB	LDB	LD/LE SPB	Proj. SPB
<b>Playout Event Sub Types</b>				
FrameSequencePlayed	X			
CPLStart	X			
CPEnd	X			
PlayoutComplete	X			
<b>Validation Event Sub Types</b>				
CPLCheck	X			
<b>Key Event Sub Types</b>				
KDMKeysReceived	X			
KDMDeleted	X			
<b>ASM Event Sub Types</b>				
LinkOpened	X	X	X	
LinkClosed	X	X	X	
LinkException	X	X	X	
LogTransfer	X	X	X	
KeyTransfer	X	X	X	
<b>Operations Event Sub Types</b>				
SPBOpen				X <sup>15</sup>
SPBClose				X <sup>15</sup>
SPBMarriage	X <sup>16</sup>	X		
SPBDivorce	X <sup>16</sup>	X		
SPBShutdown	X	X	X	
SPBStartup	X	X	X	
SPBClockAdjust <sup>17</sup>	X	X	X	
SPBSoftware	X	X	X	
SPBSecurityAlert	X	X	X	

**Table 19 Security Log Event Types and Subtypes**

<sup>15</sup> The SPBOpen and SPBClosed event types shall be detected by the projector SPB, and logged and reported by the projector's companion SPB.

<sup>16</sup> Applicable when no Link Encryption is used.

<sup>17</sup> Applicable if the SPB has a clock that is adjustable.

---

*In addition to the requirements specified in SMPTE 430-5, the following shall be normative for DCI compliance:*

- *SPBs shall log each of the "Exception" events identified in the EventSubType Record descriptions for the applicable Event Sub Type records per Table 19. The SPB shall record the appropriate Exception record(s) as specified in the SMPTE 430-5 EventSubType definitions.*
  - *Recorded Exception token(s) shall include those that prevent an EventSubType from occurring. (For example, LinkOpened and FrameSequencePlayed EventSubTypes define Exceptions that prevent the link from opening or playout from occurring.)*
  - *For the CPLCheck and KDMKeysReceived EventSubTypes, SMPTE 430-5 requires certain values from the input document to be recorded as parameters of the log record. In the case that an exception is recorded for these EventSubTypes, syntactically recognizable data items in the input document shall be recorded. (For example, when a KDMFormatError is recorded because the KDM's signing certificate has expired but the document is otherwise valid, the KDM's MessageID shall be present in the log record.)*
- *The SPBSecurityAlert Operations EventSubType shall be recorded for conditions that require replacement of the SPB (i.e., equipment tampering or failure) per Section 9.6.1.3 Digital Rights Management: Security Entity Equipment.*
- *The AuthID token for the Playout Event Sub Type events shall carry the value indicated by the SMS AuthorityID per Section 9.4.2.5 Screen Management System. Per section 9.4.2.6 Projection Systems, the AuthID token for the Operations Event Sub Type events shall indicate the identity of the authority figure responsible for the event.*

#### **9.4.6.3.9. FIPS 140-2 Audit Mechanism Requirements**

FIPS 140-2 requirements (see Section 9.5.2.5 FIPS 140-2 Requirements for Type 1 Secure Processing Blocks) require audit (logging) mechanisms for certain modifiable operating system environments for cryptographic modules. These specifications restrict the SPB operating environment to non-modifiable modes of implementation. Thus there are no additional FIPS 140-2 related logging requirements for Exhibition security devices for normal Digital Cinema operations.

*Logging requirements for SPB firmware code changes shall be implemented per Section 9.5.2.7 SPB Firmware Modifications. These device-change log records shall be accessible using the log record specifications as given in this section.*



---

#### **9.4.6.3.10. Logging Failures**

*The secure logging subsystem is required to be operable as a prerequisite to playback. Security Managers (SMs) shall not enable for playback (i.e., key) any suite for which it has not collected log records from Secure Processing Blocks (SPBs) per Section 9.4.6.3.1 Logging Requirements item (8), or if there is any indication that a next playback will not record and report log records as required. Behavior of security devices (SPB or SE) shall be specified and designed to immediately terminate operation, and require replacement, upon any failure of its secure logging operation. Resident log records, in failed SPBs and SEs shall not be purgeable except by authorized repair centers, which are capable of securely recovering such log records.*

### **9.5. Implementation Requirements**

#### **9.5.1. Digital Certificates**

Digital certificates are the means by which the Security Manager (SM) identifies other security devices. They are also used to sign security log records and in establishing Transport Layer Security (TLS) connections. This specification originally required each Secure Processing Block (SPB) to carry a single digital certificate to support each of these requirements. However, in some circumstances (e.g., new equipment designs and/or upgrades) evolving Federal Information Processing Standards (FIPS) have imposed the need for use of a second digital certificate within the Image Media Block (IMB). (FIPS requirements are addressed in Sections 9.5.2 Robustness and Physical Implementations and 9.7 Essence Encryption and Cryptography.)

To maintain compliance with FIPS requirements, this specification now includes requirements for both single and dual IMB certificate use. *Equipment vendors shall solicit FIPS expertise for guidance as to which approach is required for their implementation.*

*All Digital Cinema certificates shall use the X.509, Version 3 ITU standard (see [ITU-T Recommendation X.509 (1997 E): Information Technology – Open Systems Interconnection – The Directory: Authentication Framework, June 1997, and RFC3280]). Detailed specifications for Digital Cinema digital certificates are given in Section 9.8. Except as otherwise specified below, the requirements for all digital certificates (i.e. both single and dual use implementations) shall be the same.*

##### **9.5.1.1. Single Certificate Implementations**

*Single certificate implementations shall employ one Digital Cinema certificate in each Secure Processing Block (SPB). The requirements for use of a single SPB certificate are provided in the appropriate sections of this specification.*

*The identity of a device shall be represented by its certificate. The make and model of each certificated device shall be carried in the assigned certificate, and the serial number and device role(s) (see below) shall in particular be carried in the Common Name (CN) field of the assigned*

---

*certificate. The make, model and serial number of each certificated device shall be placed on the exterior of said device in a manner that is easily read by a human.*

*Each SPB shall enumerate the security functions of the SPB according to SMPTE 430-2 D-Cinema Operations – Digital Certificate, section 5.3.4 Naming and Roles. For purposes of efficiency, SE types shall be minimally designated according the following roles (the designation of other roles is optional):*

- *Image Media Block – SM*
- *Image Media Block with Link Encryptor – SM LE*
- *Link Decryptor Block – LD*
- *Image Processor – LD LE*
- *Projector to be married – PR*
- *Projector permanently married to an IMB – PR SM*
- *Projector permanently married to an LDB – PR LD*

#### **9.5.1.2. Dual Certificate Implementations**

Dual (two) certificates are used only with the Image Media Block (IMB), and no other SPB types are affected. Dual certificate implementations split the utility of digital certificates between the two certificates. *Dual certificate utility shall be as follows:*

- *Security Manager Certificate (SM Cert) – The SM Cert shall be used according to the same requirements as those for the above Section 9.5.1.1 Single Certificate Implementation, except for those functions specified for the below Log Signer Certificate. The SM Cert shall be the certificate associated with the identity of the IMB and shall be the target of Key Delivery Messages (KDM).*
- *Log Signer Certificate (LS Cert) – The LS Cert shall be used to 1) sign security log records per the requirements of Section 9.4.6.3.3. “Log Signatures and Integrity Controls” and 2) perform TLS session establishment functions per the requirements of 9.4.5.3.2 “Image Media Block Security Messaging.” Details of these requirements are provided in the noted sections.*

*The Log Signer Certificate shall enumerate roles only as follows:*

- *LS – Log Signer; all implementations*
- *LS LE – Log Signer for IMB with Link Encryptor*

In addition to the above, dual certificate implementations require Digital Cinema certificate validation rules that may not be reflected in the current SMPTE digital cinema specification (see DCSS Section 9.8, SMPTE 430-2: “D-Cinema Operations – Digital Certificate”). The affected

---

validation rule is driven by the “Key Usage” constraints as given in Table 2 of SMPTE 430-2 (“Field Constraints for Digital Cinema Certificates”), which is then reflected in validation rule # 6 of section 6.2 “Validation Rules”. *For dual certificate implementations validation rule # 6 shall be as stated in SMPTE 430-2 for single certificate implementations, except as follows:*

- *SM Cert – The DigitalSignature flag shall not be set.*
- *LS Cert – The KeyEncipherment flag shall not be set.*

## **9.5.2. Robustness and Physical Implementations**

This security system protects Digital Cinema content during transport and storage through the use of secret keys. Key secrecy is maintained in normal operations by cryptographic techniques dependent upon other secret keys. The physical protection afforded secret keys, and the content itself once decrypted, determine the robustness of the security implementation.

*Robustness is required for all modes of operation, both normal and abnormal.* Robustness is a function of the quality of the implementation of security devices, Exhibition operational procedures, and the security system itself.

### **9.5.2.1. Device Perimeter Definitions**

*Security equipment designs must provide physical perimeters around secrets not cryptographically protected.* The following definitions explain terminology used for tamper protection of physical perimeters. Specific tamper requirements for SPB types 1 and 2 are given in subsequent Sections of 9.5.2.

- **Tamper evident** – Penetration of the security perimeter results in permanent alterations to the equipment that are apparent upon inspection. This is the least robust perimeter, since it only reveals an attack after-the-fact, and depends on a specific inspection activity.
- **Tamper resistant** – The security perimeter is difficult to penetrate successfully. Compromise of effective tamper resistant designs requires the attacker to use extreme care and/or expensive tooling to expose secrets without physically destroying them and the surrounding perimeter(s).
- **Tamper detecting and responsive** – The security perimeter and/or access openings are actively monitored. Penetration of the security perimeter triggers erasure of the protected secrets.

### **9.5.2.2. Physical Security of Sensitive Data**

Sensitive data critical to the security of the Secure Processing Block (SPB) or SE (e.g., private keys, LE/LD or content keys) is generically referred to as a Critical Security Parameter (see Section 9.5.2.6 Critical Security Parameters and D-Cinema Security Parameters). *CSPs and plain text content essence shall be physically protected by Secure Silicon and/or Secure Processing Blocks as described below:*

- 
- **Secure Silicon** – Sensitive data contained within a Secure Silicon integrated circuit (IC) can only be compromised by a physical attack on the IC. *All type 1 and type 2 Secure Processing Blocks (SPB) shall contain a Secure Silicon IC compliant to the following requirements:*
    - a. *Secure Silicon integrated circuits used for Digital Cinema security applications shall meet FIPS 140-2 level 3 area five (physical security) requirements as defined for “single-chip cryptographic modules” (no other FIPS 140-2 area requirements are mandated).*
    - b. *Other than as part of the manufacturing process, SPB private keys used for device identity (see section 9.5.1 “Digital Certificates”) shall not exist outside of the Secure Silicon IC. For purposes of clarity, this means that (1) private keys (whether encrypted or not) shall not be moved or copied from Secure Silicon, and (2) the CipherValue element(s) of the KDM’s AuthenticatedPrivate element shall be decrypted by and within the Secure Silicon IC.*
    - c. *Decrypted (plain text) content image keys may be moved from the Secure Silicon IC for purposes of decrypting image essence during playout only. They shall at all other times be contained within the Secure Silicon IC, or be stored off-chip in an encrypted fashion per the requirements of Section 9.7.4 “Protection of Content Keys”.*
  - **Secure Processing Block (SPB) Hardware Module** – Sensitive data will only be exposed by penetration of a physical barrier, which surrounds the electronics.
    - a. *All Secure Processing Block (SPB) module designs shall implement hardware module perimeter protection that prevents access to internal circuitry and detects opening of the module perimeter. Further protection of keys and clear text content should use techniques such as burying sensitive traces, applying tamper resistant integrated circuit coverings, and tamper responsive circuitry. Detailed SPB type 1 and SPB type 2 physical protection requirements are defined below in Section 9.5.2.4 Specific Requirements for Type 2 Secure Processing Blocks and Section 9.5.2.5 FIPS 140-2 Requirements for Type 1 Secure Processing Blocks.*
    - b. *Other than the SMS, no Security Entity (SE) shall exist outside the protection of a SPB type 1.*
  - **Software** – Protection implemented in software can be compromised through modifications to the software, inspection of memory, or monitoring of bus signals.
    - a. *Software protection methods shall not be used to protect Critical Security Parameter or content essence.*

### 9.5.2.3. Repair and Renewal

The following address restrictions on repair and renewal of Secure Processing Blocks (SPBs) and associated cryptographic parameters:

- 
- *Type 1 SPBs may be field replaceable (as an entire SPB module) by Exhibition, but shall not be field serviceable (e.g., SPB type 1 maintenance access doors shall not be open-able in the field).*
  - *The secure silicon device, contained within a SPB type 2, shall not be field serviceable, but may be field replaceable. It shall not be accessible during normal SPB type 2 operation or non-security-related servicing.*
  - *Repair and renewal processes for an SPB type 1 and SPB type 2 shall be performed under the supervision of the security equipment vendor. Maintenance of the SPB type 2 (projector) is permitted for non-security components accessible via maintenance openings.*
  - *All type 1 SPBs shall be issued a new private/public key pair and certificate upon any repair or renewal process that requires opening of the SPB perimeter. (Note that Section 9.7.6 precludes maintaining records of private key information.)*

Repair and renewal is limited to failed devices, or devices which have lost or zeroed their secrets (e.g., private keys or digital certificates). Such maintenance does not effect the device's FIPS 140-2 certification or compliance, as long as Section 9.5.2.5 FIPS 140-2 Requirements for Type 1 Secure Processing Blocks requirements are met. Requirements for firmware changes to SPBs are given in Section 9.5.2.7 SPB Firmware Modifications.

#### **9.5.2.4. Specific Requirements for Type 2 Secure Processing Blocks**

The SPB type 2 container has been defined specifically for protection of image essence exiting either a Link Decryptor Block or Image Media Block (companion SPBs to the projector SPB) and entering the projector. The purpose of this SPB is to protect the image essence signal as far as practical, recognizing that "all the way to light" production is probably not possible. It is also preferable not to impose formal FIPS 140-2 requirements on this SPB, as the security and signal flow functions are relatively simple.

Requirements for projection systems were defined in Section 9.4.3.6.1 "Normative Requirements: Projection Systems." As explained there, the type 2 SPB – also referred to as a projector SPB – is permitted to be opened for maintenance. To assure adequate protection of signals and circuits within the projector SPB, the following address physical requirements, and are in addition to those of section 9.4.3.6.1:

- *The projector SPB shall be designed for two types of access: "security servicing" and "non-security servicing." Security servicing is defined as having access to the companion SPB's output image essence signal and/or the projector SPB access opening detection circuits and associated signals.*

*For non-security servicing (i.e., maintenance), the above signals / circuits shall not be accessible via the SPB's maintenance door opening(s). In other words, there shall be a partition that separates security-related signals/circuits from the non-security related maintenance accessible areas, and access to security related areas shall not*

---

*be possible without causing permanent and easily visible damage.*

*Security servicing shall be performed only under the supervision of the projector manufacturer per Section 9.5.2.3 Repair and Renewal.*

- *Projector SPB access doors or panels shall be lockable using pick-resistant mechanical locks employing physical or logical keys, or shall be protected with tamper-evident seals (e.g., evidence tape or holographic seals).*
- *Protection from external probing of security-sensitive signals (i.e., image essence and access opening/detecting circuits and signals) shall be provided by assuring barriers exist to prevent access to such signals via ventilation holes or other openings.*

In summary, the projector SPB physical perimeter provides for maintenance access and access door opening detection, and the internal design enables access for non-security related servicing. Exhibition visual inspection is relied upon to detect physical abuse that might allow compromise of, or access to, decrypted image essence.

#### **9.5.2.5. FIPS 140-2 Requirements for Type 1 Secure Processing Blocks**

*Robustness requirements for Digital Cinema Secure Processing Blocks (SPBs) shall follow the guidelines of the Federal Information Processing Standards [FIPS PUB 140-2]<sup>18</sup>. A summary of these requirements is shown in the table below.*

*FIPS 140-2 specifies eleven areas for evaluation against a rating, which shall be performed by US government recognized independent laboratories.*

*All SPB type 1 shall meet and be certified for the requirements of FIPS 140-2 Level 3 in all areas except those subject to the following exceptions or additional notes (the Nr indicators refer to the table items by row):*

- *Nr 2 – Logical data port separation requirements shall be supported by the use of Transport Layer Security (TLS) protection on well known port 1173 as defined in Section 9.4.5.2.3 General RRP Requirements.*
- *Nr 6 – The software operating environment of Secure Processing Blocks (SPBs) shall be restricted to the Limited Operational Environment. This eliminates the requirements for Common Criteria (CC) and Evaluation Assurance Level (EAL) testing, and any additional FIPS140-2-specific logging/audit processes other than those specified in Section 9.5.2.7 SPB Firmware Modifications for firmware modifications.*
- *Nr 7 – Section 9.7 Essence Encryption and Cryptography of these Digital Cinema requirements shall supersede any conflicts with Nr 7.*

---

<sup>18</sup> Readers unfamiliar with [FIPS PUB 140-2] will need to refer to the standards text to fully understand the table and exceptions.

- 
- Nr 8 – *Secure Processing Blocks (SPBs) shall only be required to meet Security Level 2 business use A FCC class requirements.*
  - Nr 10 – Design Assurance requirements may meet Security Level 2 requirements.
  - Nr 1 and Nr 11 – *Vendor-specified Security Policy specifications shall be in alignment with and fully support the requirements of this Digital Cinema specification, in addition to vendor-specific policies.*

Nr	Section	Security Level 1	Security Level 2	Security Level 3	Security Level 4
1	<b>Cryptographic Module Specification</b>	Specification of cryptographic module, cryptographic boundary, Approved algorithms, and Approved modes of operation. Description of cryptographic module, including all hardware, software, and firmware components. Statement of module security policy.			
2	<b>Cryptographic Module Ports And Interfaces</b>	Required and optional interfaces. Specification of all interfaces and of all input and output data paths.		Data ports for unprotected critical security parameters logically separated from other data ports.	
3	<b>Roles, Services And Authentication</b>	Logical separation of required and optional roles and services.	Role-based or identity-based operator authentication.	Identity-based operator authentication.	
4	<b>Finite State Model</b>	Specification of finite state model. Required states and optional states. State transition diagram and specification of state transitions.			
5	<b>Physical Security</b>	Production grade equipment.	Locks or tamper evidence.	Tamper detection and response for covers and doors.	Tamper detect & response. EFP and EFT.
6	<b>Operational Environment</b>	Single operator. Executable code. Approved integrity technique.	Referenced PPs evaluated at EAL2 with discretionary access control mechanisms and auditing.	Referenced PPs plus trusted path evaluated at EAL3 plus security policy modeling.	Referenced PPs plus trusted path evaluated at EAL4.
7	<b>Cryptographic Key Management</b>	Key management mechanisms: random number and key generation, key establishment, key distribution, key entry/output, key storage, & key zeroization.			
		<i>Secret and private keys established using manual methods may be entered or output in plaintext form.</i>		<i>Secret and private keys established using manual methods shall be entered or output encrypted or with split knowledge procedures.</i>	
8	<b>EMI/EMC</b>	47 CFR FCC Part 15. Subpart B, Class A (Business use). Applicable FCC requirements (for radio).		47 CFR FCC Part 15. Subpart B, Class B (Home use).	
9	<b>Self-Tests</b>	Power-up tests: cryptographic algorithm tests, software/firmware integrity tests, critical functions tests. Conditional tests.		Statistical RNG tests. Callable on demand	Statistical RNG tests performed at power-up.
10	<b>Design Assurance</b>	Configuration management (CM). Secure installation and generation. Design and policy correspondence. Guidance documents.	CM system. Secure distribution. Functional specification.	High-level language implementation.	Formal model. Detailed explanations (informal proofs). Pre/post conditions.
--	<b>Mitigation of Other Attacks</b>	Specification of mitigation of attacks for which no testable requirements are currently available.			

**Table 20: Summary of FIPS 140-2 Security Requirements<sup>19</sup>**

Table 20 does not reflect the most current FIPS 140-2 table, and shall be considered informative (refer to FIPS 140-2 publications for the most current version of this table).

<sup>19</sup> From Section 4 of [FIPS PUB 140-2]



---

*FIPS 140-2 level 3 devices provide physical and logical protection of their parameters and functions 24/7 and shall be able to respond to attacks under both powered and un-powered conditions. This means that if a type 1 SPB requires a power source to accomplish tamper detection and response, it must zeroize its Critical Security Parameters (CSPs) prior to any situation arising where such power source may not be available. By way of example, if a type 1 SPB is in storage and relying upon a battery for tamper detection and response, it must self-destruct prior to a battery depletion condition which would not support proper tamper detection and/or response.*

#### **9.5.2.6. Critical Security Parameters and D-Cinema Security Parameters**

A requirement of FIPS-140-2 is to list the Critical Security Parameters (CSP) that are important for the security of Digital Cinema cryptographic module(s) (Secure Processing Block) and its functions. *The following CSPs shall receive Secure Processing Block (SPB) type 1 protection, whenever they exist outside of their originally encrypted state.*

- 1. Device Private Keys – RSA private key that devices use to prove their identity and facilitate secure Transport Layer Security (TLS) communications.*
- 2. Content Encryption Keys – KDM AES keys that protect content.*
- 3. Content Integrity Keys – HMAC-SHA-1 keys that protect the integrity of compressed content (integrity pack check parameters).*
- 4. [This item left blank intentionally.]*
- 5. Link Encryption Keys – Keys that protect the privacy and integrity of uncompressed content for link encryption.*
- 6. Transport Layer Security (TLS) secrets – These are transient keys/parameters used or generated in support of TLS and Intra-Theater Messaging (ITM). (TLS secrets associated with the SMS end point of the SMS-SM TLS connection are not considered CSPs.)*

*The following items are not considered FIPS 140-2 CSPs, but are considered D-Cinema Security Parameters, and shall at all times be protected by a type 1 SPB perimeter (except where log data is extracted per Section 9.4.6.3).*

- 1. Watermarking or Fingerprinting command and control – Any of the parameters or keys used in a particular Forensic Marking process.*
- 2. Logged Data – All log event data and associated parameters constituting a log record or report.*

#### **9.5.2.7. SPB Firmware Modifications**

The Limited Operational Environment operating system requirement of FIPS 140-2 Section 9.5.2.5 FIPS 140-2 Requirements for Type 1 Secure Processing Blocks restricts SPBs type 1 and the secure silicon chip of SPB type 2 from having their operating system or firmware modified in

---

the field. The following defines the requirements for making firmware<sup>20</sup> changes to these security devices. *FIPS 140-2 constrained devices shall:*

- *Be designed such that their firmware cannot be modified without the knowledge and permission of the original manufacturer.*
- *Require a Digital Cinema compliant certificate that authenticates and confirms the identity of the authority figure responsible for making a firmware change, and shall include time/date and version number information associated with any firmware change, in addition to the authority figure.*
- *Not undergo firmware changes without informing potentially affected information bases that support Digital Cinema equipment operations (e.g., databases used by stakeholders for facility lists, KDM and TDL creation), and the owner of the device.*
- *Log the firmware change event by meeting FIPS 140-2 Operational Environment (row 6 of Table 20: Summary of FIPS 140-2 Security Requirements) audit/recording requirements of the Operating System Requirements subsection Security Level 3, except that Common Criteria (CC) and Evaluation Assurance Level (EAL) certification mandates shall not be required. The requirements for FIPS Level 3 audit/recording are encouraged but shall be optional.*
- *Enable the extraction of the above firmware change related log records using standard log record messages per Section 9.4.6.3 Logging Subsystem. For the delivery of these log records, it shall be mandatory that the records be signed.*
- *Follow FIPS 140-2 certification body change notification requirements regarding modifications to security devices. Undergo re-certification if required.*

### **9.5.3. Screen Management System (SMS)**

*There are no physical constraints or requirements imposed on the SMS by the security system (i.e., no SPB requirements); however, the SMS implementation shall not otherwise weaken or effect the security operations of other Security Entities or SPBs.*

### **9.5.4. Subtitle Processing**

See Section 9.7.3 Subtitle Encryption.

### **9.5.5. Compliance Testing**

Compliance Testing is the process of qualifying Secure Processing Blocks (SPBs) and their Security Entities for use in Digital Cinema systems. *All SPBs shall be subject to qualifying criteria in the following areas:*

---

<sup>20</sup> The term firmware shall mean all operating system, software, firmware or ROM based code within the SPB type 1 SPB type 2 silicon chip.

- 
- *Compliance to Intra-Theater Messaging (ITM) specifications – The SPB and internal logical SEs shall interpret and respond to the standard ITM message set according to the appropriate Section 9.4.5.2.4 Request-Response Pairs (RRP) category as specified herein.*
  - *Image Media Blocks shall support compliance with standardized Extra-Theater Messaging (ETM) specifications, in addition to the above compliance requirement for ITMs.*
  - *The SM and Secure Processing Block systems shall meet the functional requirements as specified in Sections 9.4.3.5 Functions of the Security Manager (SM) and 9.4.3.6 Functional Requirements for Secure Processing Block Systems, respectively.*
  - *Compliance to SPB physical and logical requirements – Each SPB shall be evaluated against physical and logical requirements based on the SPB type per Section 9.5.2 Robustness and Physical Implementations, including FIPS 140-2 requirements as applicable.*

*Device vendors shall issue Digital Cinema certificates only to devices that comply with this specification.*

*A device that does not meet all of the above criteria shall not be installed in a DCI compliant Digital Cinema system. A device that does not continue to meet all the above criteria shall be declared a Security Function Failure, and shall be taken out of service until repaired.*

#### **9.5.6. Communications Robustness**

The following are required for the exhibition of content and security communications, and communications networks:

- *Theater networks shall protect security system(s) from the threat of external and internal network-borne attacks by the use of appropriate firewalls. At a minimum, each auditorium shall have such firewall protection for any communications interface(s) connecting to the intra-auditorium security network. In particular, such firewall protection shall prevent (filter) communications to or from any well-known port 1173, other than directly between security equipment within a single auditorium.*
- *Digital Cinema security messages and content shall not be carried over a wireless network, but shall be carried over wire or optical cables.*
- *The portions of the network used to carry any security messages or content shall be logically or physically separated from any wireless network device. At a minimum, a properly configured firewall shall separate the wired network that carries security messages or content from any wireless network operated at the same facility.*
- *The network cabling or cabling trough should not be publicly accessible on the premises.*

### **9.6. Security Features and Trust Management**

This section describes the standardized Digital Cinema security operational features, and how “trust” is communicated and enforced to ensure security features are reliably executed. A security policy is what results once the variables that develop, from the overall security system design and implementation, are constrained according to desired operational characteristics. An open architecture security system

---

should not dictate any specific policy, but enable stakeholders to agree on one more policies that support business needs. Once policy has been decided, it can be described operationally as the security feature set.

### **9.6.1. Digital Rights Management**

This section identifies various features and functions that describe the operation of the security system. For each auditorium equipment suite, the security system consists of three types of components involved in Digital Rights Management (DRM):

- 1) The Screen Management System (SMS)
- 2) The Security Manager (SM)
- 3) The associated security equipment (e.g., Media Block, Link Decryption Block)

The last two components have access to, and process, Digital Cinema security information (secrets), such as content keys or plain text content. They are the primary subject of these security specifications. The Screen Management System does not have access to such secrets. But because the Screen Management System initiates security-related activity, it is considered a participant in security events.

The basic business philosophy is to “control lightly, audit tightly.” Per this philosophy, a movie will fail to playback only under four circumstances:

- 1) Wrong location ) (see Table 21: Examples of Security Manager Events)
- 2) Wrong date and time (outside the engagement window) (see Table 21: Examples of Security Manager Events)
- 3) Unauthorized device (equipment is not accepted by the content owner) (see Table 21: Examples of Security Manager Events)
- 4) Failure of, or tampering, with security equipment (see Table 22: Examples of Failure or Tampering of Security Equipment)

Compliance to security system logging requirements ensures that all events having security implications will generate associated log records that are stored in the Image Media Block. These log records can be accessed by the exhibitor’s Screen Management System, and reports can be provided to appropriate distributors under contractual obligations.

All three types of security system components (Screen Management System, Security Manager, security equipment) have defined roles and responsibilities (e.g., to perform their security functions and generate log records), and overall security depends upon their proper operation. The descriptions below detail the three types of security system components. Included in the Security Manager and security equipment description are tables showing possible security system operational scenarios and how the system responds to a particular issue.

The tables are also designed to be informative to parties interested in understanding business issues in relation to the Digital Cinema security system. It shows that the security system’s reach is limited to only those areas necessary for ensuring persistent protection of content and security data (keys), enabling content to play within a designated time window, and the provisioning of reliable log data

(see Table 21: Examples of Security Manager Events and Table 22: Examples of Failure or Tampering of Security Equipment).

#### 9.6.1.1. Digital Rights Management: Screen Management System

The Screen Management System is responsible for managing Exhibition functions such as showtime movie playback, and is under the control of the Exhibitor. The Screen Management System manages playback functions via the Security Manager, however the Security Manager is at all times in control of and responsible for security functions and events. The full compliment of Exhibition operational events therefore consists of those under the control of the Security Manager and those under the control of the Screen Management System.

#### 9.6.1.2. Digital Rights Management: Security Manager (SM)

The Security Manager is the executor of Digital Rights Management for each auditorium. It controls content keys and the delivery of such keys to the appropriate security equipment to enable playback of encrypted content.

Each Security Manager (and the Image Media Block it is part of) is assigned to a single projector. Keys are considered active for the business defined play period. Subject to security equipment authentication, proper operation, and integrity checks (see Section 9.4.3 Theater Security Operations), the Security Manager exercises no control over playback, other than content key delivery during the valid play period. Under private business negotiations, a Distributor may provide keys for selected or all Security Managers (i.e., projectors) in a complex.

Item, Observation or Issue	Approach
Authorized auditorium	KDM (keys) is sent to authorized auditorium SM
Engagement Play-out Window	KDM contains designated key use time/date window
Only known & trusted devices are enabled	SM authenticates equipment prior to key delivery
Modified Movie File	At playback, SM checks and logs movie against CPL

**Table 21: Examples of Security Manager Events**

The above table depicts events related to the Security Manager and the system's behavior. A film will not play-out if there is a failure in any of the items in rows 1, 2 and 3 due to wrong location (row 1), wrong date/time (row 2), or the attempted use of an unauthorized device (row 3). In the event of modification in a movie file (row 4), the file should be replaced, but there are no Security System controls preventing an Exhibitor from playing-out a modified file. This event, like all security events, will be logged.

---

### 9.6.1.3. Digital Rights Management: Security Entity (SE) Equipment

*Security Entity equipment must perform to specified standards and function as designed. The Security Manager will continuously test for proper Security Entity identification (authentication), operation and physical integrity (tampering). Content playback is restricted to passing all security tests at all times.*

Item, Observation or Issue	Approach
Security equipment tampering or failure	A tampered or failed device is non-functional until replaced
Auditorium (intra-suite) Security Network	Network must be operative to initiate playback

**Table 22: Examples of Failure or Tampering of Security Equipment**

*The above table depicts tampering or failure of security equipment. Security equipment that has been tampered with or is malfunctioning (row 1) shall not continue operation and must be replaced before playback can commence (or continue). An example of malfunctioning security equipment is a Media Block that no longer performs one of its security functions (e.g., decryption, Forensic Marking, logging). If the auditorium security network is inoperative (row 2), playback cannot start. However, the security system will not cause playback to stop upon failure of the network during a show.*

### 9.6.2. “Trust” and the Trusted Device List (TDL)

In a “trust” relationship, it is said “A trusts B regarding X”. More specifically, the relying party A believes that B will behave in certain predictable ways under a certain range of conditions. This behavior-based definition can apply both to business relationships and to the more formalized regime of standardized security devices. And in fact, a useful Digital Cinema trust system must bridge the former to the latter.

When a Distributor trusts a piece of equipment, his level of confidence in its behavior is based on several factors such as those in Table 23

	Factor	Root of Trust
1	Robust equipment design	Manufacturer and certification organization
2	Reliable manufacturing process	Manufacturer
3	Properly installed	Installer and organization operating device
4	Properly maintained (e.g., required firmware or security updates)	Organization operating device, manufacturer and certification organization
5	Properly managed (configured, inspected and operated in accordance with expectations during operational life)	Organization operating device
6	Has not been tampered with before or after installation	Organization operating device, certification organization

**Table 23: Factors Supporting Trust in a Security Device**

Protecting the content keys under a full range of potential situations can be a complex task, representing a set of behaviors involving rules and policy that meet the requirements of these specifications and (optionally) the particular business relationship. To simplify trust issues for the Digital Cinema environment, the TDL approach to equipment trust communications has been defined. In this approach, Rights Owners will indicate their approval of specific trusted equipment to be used in conjunction with an engagement by placing the identification of trusted equipment (Secure Processing Blocks and projectors) into the Key Delivery Messages (KDMs) that are sent to Security Managers. Security Managers will trust and accept devices so listed for all security functions subject to the device's certificate declared roles (see Section 9.5.1 Digital Certificates)

*The content of TDLs (e.g., facility-wide, auditorium-specific, inclusive of spares) shall be according to business party agreement, and is out of scope of these specifications.*

#### **9.6.2.1. Trust Domains**

The SM Security Domain is represented by the collection of security devices associated with a single SM that work together to perform a security function. In this system, the SM Security Domain and its Trust Domain<sup>21</sup> are equal, and in the theater these domains are a single auditorium equipment suite. Multiple trust domains are typically used (chained) together to achieve overall security management objectives (e.g., distributing content keys from post-production to Distribution and Exhibition via multiple KDMs).

The SM functions as an anchor for a given Trust Domain. For convenience, this specification uses descriptors such as Distributor SM, Auditorium SM, etc., but it will be recognized that the security system does not mandate any particular topology for Security Managers (SMs) other than requiring that the Image Media Block contain a Security Manager.

---

<sup>21</sup> Trust Domain areas also exist for post-production and distribution, but are out of scope.

---

The security system must be sufficiently flexible to support complex groupings and relationships between the Rights Owners, Distributors and Exhibitors. Trust Domains represent the essence of these relationships. The required flexibility is achieved through trust communications that supports the existence of simultaneous multiple overlapping domains, as opposed to force-fitting them into a single domain. In practice, this is implemented via the Digital Certificate chains and TDL that is part of the KDM. Digital Certificate chaining and TDL management is out of scope of these standards.

#### **9.6.2.2. Authenticating Secure Processing Blocks & Linking Trust Through Certificates**

A Digital Cinema Certificate is a declaration by a trusted organization, such as a manufacturer, that the security device is a particular make and model and is certified (i.e., found compliant to this specification) to perform identified DC roles (e.g., perform Image or Sound Decryption or provide SPB physical protection functions). The certificate is cryptographically bound to the security device it represents, in such a way that the authenticity of the device is easy to verify. The Certificate is also cryptographically bound to the entity that issued it. This latter binding can be authenticated by knowing and trusting another certificate, that of the certificate issuing entity, called the issuing authority or Certificate Authority. Certificates of issuing authorities are called root certificates.

The design of the certificate includes a technique called chaining, which is an elegant and cryptographically strong method of linking certificates back to the root certificate owned by its issuing authority. Thus, where required an entity can authenticate end entity leaf certificates by knowing just the (set of) root certificates it needs.

The use of certificates to authenticate Secure Processing Blocks (SPB) or Security Entities (SEs) prevents the theft of content by substituting a rogue device for a legitimate Secure Processing Block (SPB) or Security Entity (SE) *The security system requires (only) Image Media Block Security Managers to perform authentication functions, permitting the SM to safely extend trust to encompass those SPBs and SEs, thus forming its trust domain.*

#### **9.6.2.3. Identity vs. “Trust”**

In the theater, the SM uses certificates for two primary functions: 1) authenticating a Secure Processing Block’s (SPB’s) identity and roles, and 2) establishing the secure Transport Layer Security (TLS) session for Intra-Theater Messaging communications with that Secure Processing Block (SPB). These two functions are performed simultaneously when the SM and Secure Processing Block (SPB) set up their Transport Layer Security (TLS) session, during which, the Secure Processing Block (SPB) presents its certificate chain to the SM. This process opens secure communications between security devices in each auditorium suite, and allows the SM to identify suite equipment.

However, decisions that the SM makes regarding its “trust” in accepting the remote Secure Processing Blocks (SPBs) as capable of playing content (receiving content keys, etc.) is



---

independent of the above identity/authentication process. Trust decisions are made on a Rights Owner by Rights Owner basis, and communicated via the TDL in the KDM (see Section 9.4.3.1 Transport Layer Security (TLS) Establishment and Secure Processing Block (SPB) Authentication and Section 9.4.3.5 Functions of the Security Manager (SM)).

#### **9.6.2.4. Revocation and Renewal of Trust**

The use of TDLs in the KDM allows a simple and effective way for Distributors to communicate trust in exhibition equipment to the responsible Security Managers. However, the source (database) of equipment lists, from which TDL information is derived must be managed with respect to revocation and renewal issues per Table 23: Factors Supporting Trust in a Security Device, above.

In routine operation, trusted equipment remains trusted indefinitely. However there may be situations in which trust in a security device needs to be terminated or restored. Controlling change in trust relationships is an important aspect of trust management.

Database references for TDL creation must be managed with respect to trust issues. However, these are outside the scope of this specification.

## **9.7. Essence Encryption and Cryptography**

The security system employs widely used and rigorously tested ciphers for use in Digital Cinema. The following are requirements pertaining to Digital Cinema applications for ciphers and associated security parameters.

### **9.7.1. Content Transport**

Content security is transport agnostic, and can be accomplished by either electronic or physical means. *Other than as authorized and intended by Rights Owners (e.g., to support Distribution practices or requirements), content shall only be decrypted at playback time at the exhibition site under the policy of the SM.*

### **9.7.2. Image and Sound Encryption**

*The AES cipher, operating in CBC mode with a 128 bit key, shall be used for Digital Cinema content encryption. See [FIPS-197 "Advanced Encryption Standard (AES)" November 26, 2001. FIPS-197] and Section 5.3.2 MXF Track File Encryption, for MXF track file encryption details.*

*The content Rights Owner shall determine which, if any, of the essence types in the composition are encrypted for distribution.*

### **9.7.3. Subtitle Encryption**

*Subtitle encryption shall comply with the SMPTE published standard "SMPTE 429-5 D-Cinema Packaging - Timed Text Track File".*

*Subtitle encryption is directed primarily against interception during transport, and cryptographic protection within the theater is not required. For example, plaintext subtitle content may be*

---

transmitted from a server device to a projection unit. It is preferred, but not required, that subtitle content be maintained in encrypted form except during playback.

#### **9.7.4. Protection of Content Keys**

*The RSA Public Key Cipher (with 2048-bit key) shall be used to protect keys for distribution. This is accomplished by the requirements of the Key Delivery Message.*

The above RSA asymmetric protection, AES (with 128-bit keys) or TDES (with 112-bit key) symmetric ciphers, may be used to protect the storage of keys once decrypted from the KDM within a Media Block (e.g., where off-secure-chip memory is used for key caching within a Media Decryptor, for example).

#### **9.7.5. Integrity Check Codes**

FIPS requirements may obsolete or replace certain older cryptographic technologies or standards, rendering them unacceptable for use. *The requirements of this section shall be superseded by the FIPS 140-2 or FIPS 140-3 requirements in effect as of the date of FIPS compliance testing and certification per Section 9.5.5 Compliance Testing.* Equipment suppliers are cautioned to take into consideration NIST and FIPS transition timing and FIPS validation lead times.

*Data integrity signatures (hash values) shall be generated/calculated according to the PKCS-1 Digital Signature Standard, as specified in [IETF RFC 3447 (RSA and SHA-256)]. All signatures shall use SHA-256. Digital Certificates in X.509v3 format as constrained according to Section 9.8., shall be used to authenticate signatures.* Signature element definitions and other signature details are available in the specification for each signed data structure.

*Cryptographic data integrity checksums shall be ensured according to the HMAC-SHA-1 algorithm, as specified in [FIPS PUB 198a “The Keyed-Hash Message Authentication Code.”]*

#### **9.7.6. Key Generation and Derivation**

*Asymmetric keys (RSA keys) shall be generated as specified in [IETF RFC 3447]. Symmetric key generation shall be per ANSI X9.31.* FIPS requirements may obsolete or replace certain older cryptographic technologies or standards, rendering them unacceptable for use. *The requirements of this paragraph shall be superseded by the FIPS 140-2 or FIPS 140-3 requirements in effect as of the date of FIPS compliance testing and certification per Section 9.5.5 Compliance Testing.* Equipment suppliers are cautioned to take into consideration NIST and FIPS transition timing and FIPS validation lead times.

*A vendor that pre-loads an RSA private key into a device (e.g., secure silicon per Section 9.5.2.2 Physical Security of Sensitive Data) shall ensure that these pre-loaded keys are unique to each device made by that vendor. The vendor shall not keep any record of the preloaded private keys, though they can keep records of the matching public keys. RSA keys shall be 2048 bits in length, and may be generated from two or three prime numbers, each of which must be at least 680 bits long. The mechanism used to generate RSA key pairs must have at least 128-bits of entropy (unpredictability).*

---

*A vendor that pre-loads an AES or TDES symmetric key into a device shall generate each key with a high quality random number generator with at least 128 bits of entropy (112 bits for TDES). The vendor may not keep any records of these symmetric keys.*

#### **9.7.7. Numbers of Keys**

*No more than 256 keys shall be used to encrypt the essence of a single composition (i.e., Composition Playlist). To support multiple shows, the Media Decryptor shall be capable of securely caching at least 512 keys. The Show Playlists may be comprised of multiple compositions.*

### **9.8. Digital Certificate, Extra-Theater Messages (ETM), and Key Delivery Messages (KDM) Requirements**

*The following Society of Motion Picture and Television Engineers (SMPTE) published standards shall be utilized:*

- 1. SMPTE430-1: D-Cinema Operations- Key Delivery Message (SMPTE3383B),*
- 2. SMPTE430-2: D-Cinema Operation- Digital Certificate (SMPTE3384B), and*
- 3. SMPTE430-3: D-Cinema Operations- Generic Extra-Theater Message Format (SMPTE3385B).*

---

THIS PAGE LEFT BLANK INTENTIONALLY

## 10. GLOSSARY OF TERMS

<b>AES</b>	Acronym for Advanced Encryption Standard
<b>AES</b>	Acronym for Audio Engineering Society
<b>AES3</b>	Audio Engineering Society - Recommended Practice for Digital Audio Engineering Serial transmission format for two-channel linearly represented digital audio data
<b>ANSI</b>	Acronym for American National Standards Institute
<b>Answer Print</b>	A color-corrected film print made directly from the cut film negative. It is also the culmination of the creative color timing process, where final creative approval is granted before the film is duplicated for release
<b>API</b>	Acronym for Application Programming Interface
<b>BER</b>	Acronym for Basic Encoding Rules
<b>Broadcast Wave</b>	Digital Audio file format developed and standardized by the EBU (European Broadcast Union, a standardization organization)
<b>Burned-In</b>	Where visual data that is normally supplemental to a motion picture is irrevocably added to the motion-picture image by compositing the data with the underlying image
<b>Captions</b>	Text that is a representation, often in the same language, of dialog and audio events occurring during scenes of a motion picture. (Generally associated with a dialog and audio event translation for the deaf and hard of hearing.)
<b>CBC</b>	Acronym for Cipher Block Chaining mode
<b>CBR</b>	Acronym for Constant Bit Rate for image compression
<b>Central Storage</b>	A central location where the packaged Digital Cinema content is stored for a multiple screen installation
<b>Chunk</b>	A section of a PNG file. Each chunk has a type indicated by its chunk type name. Most types of chunks also include some data. The format and meaning of the data within the chunk are determined by the name.
<b>CIE</b>	Acronym for International Commission on Illumination (Commission Internationale de l'Eclairage)
<b>Closed</b>	Referring to visual data that is supplemental to a motion picture being displayed off-screen
<b>COC</b>	Acronym for Coding style Component – see JPEG 2000 specification [ISO/IEC 15444-1]
<b>COD</b>	Acronym for Coding style Default – see JPEG 2000 specification [ISO/IEC 15444-1]

<b>Composition</b>	A motion picture, or a trailer, or an advertisement, etc. Composition consists of a metadata Composition Playlist along with the essence and other metadata track files that define the work.
<b>Container Level</b>	Metadata that indicates the size of the image/structure container and the frame rate of the images – this does not indicate the image structure or resolution
<b>CPL</b>	Acronym for Composition Playlist, the definitive Playlist for specifying how a Composition is played and what track files are required
<b>CPRL</b>	Acronym for Component Position Resolution Layer – see JPEG 2000 specification [ISO/IEC 15444-1]
<b>CSP</b>	Acronym for Critical Security Parameter
<b>D/HOH</b>	Acronym for Deaf and Hard Of Hearing
<b>DCDM</b>	Acronym for Digital Cinema Distribution Master. A master set of files that have not been compressed, encrypted, or packaged for Digital Cinema distribution. The DCDM contains essentially all of the elements required to provide a Digital Cinema (DC) presentation.
<b>DCDM*</b>	Acronym for Digital Cinema Distribution Master*. When the DCP is unpackaged, decrypted and decompressed, it is referred to as the DCDM*. The DCDM* is visually indistinguishable from the original DCDM.
<b>DCI</b>	Acronym for Digital Cinema Initiatives, LLC
<b>DCP</b>	Acronym for a Digital Cinema Package, the set of files that are the result of the encoding, encryption and packaging process
<b>DER</b>	Acronym for Distinguished Encoding Rules
<b>DES</b>	Acronym for Data Encryption Standard. DES was adopted as a federal standard in 1976 [FIPS (46-3)] and [ANSI standard X9.32]
<b>Distribution Package</b>	The collection of files delivered by the distributor to the exhibitor. A Distribution Package may contain pieces of a Composition or several compositions, a complete Composition, replacement/update files, etc.
<b>DM</b>	Acronym for Descriptive Metadata
<b>DRM</b>	Acronym for Digital Rights Management
<b>DSM</b>	Acronym for Digital Source Master, a digital master created in post-production from which different versions and duplication masters may be created.
<b>e.g.</b>	Abbreviation for the Latin phrase <i>exempli gratia</i> , meaning “for example”
<b>End Credits</b>	A credit sequence generally shown at the end of a motion picture
<b>Essence</b>	Image, audio, subtitles, or any content that is presented to a human being in a presentation
<b>ETM</b>	Acronym for Extra-Theater Message

<b>Event Playlist</b>	A playlist of Compositions, describing an assembly of Compositions in sequence. An Event Playlist is typically created by a content distributor and transferred to exhibition.
<b>Fingerprint</b>	Dynamic playback or distribution watermark
<b>FIPS</b>	Acronym for Federal Information Processing Standards
<b>FM</b>	Acronym for Forensic Marking
<b>FMID</b>	Acronym for Forensic Marking Identification. The FMID is a unique fixed identifier of the specific instance of the Forensic Marking application.
<b>Forensic Marking</b>	Data embedded in essence to provide forensic tracking information in the event of content theft. Such marking can be visible or non-visible, audible or non-audible.
<b>FPS</b>	Acronym for Frames Per Second
<b>Generic Forensic Mark Inserter</b>	In this architecture, metadata is first created at authoring that contains: 1) locations within the title where forensic marking may be inserted, and 2) commands that set the type of steganographic marking to be used to encode the actual forensic information. In the theater, at the time of playback, the metadata is used to instruct the inserter in the Media Block how, where, and when the required information will be hidden within the sound and/or picture.
<b>GPIO</b>	Acronym for General Purpose Input or Output
<b>GUI</b>	Acronym for Graphical User Interface
<b>HMAC</b>	Acronym for Hashing Message Authentication Codes
<b>HVS</b>	Acronym for the Human Visual System
<b>Hz</b>	Abbreviation for Hertz, a unit of frequency expressed in cycles per second
<b>IANA</b>	Acronym for Internet Assigned Numbers Authority
<b>i.e.</b>	Abbreviation for the Latin phrase id est, meaning “that is”
<b>ICT</b>	Acronym for Irreversible Color Transformation – see JPEG 2000 specification [ISO/IEC 15444-1]
<b>IEC</b>	Acronym for International Electrotechnical Commission
<b>IETF</b>	Acronym for Internet Engineering Task Force
<b>IMB</b>	Acronym for Image Media Block
<b>IP</b>	Acronym for Intellectual Property
<b>ISAN</b>	Acronym for International Standards Audiovisual Number
<b>ISO</b>	Acronym for International Organization for Standardization
<b>ITM</b>	Acronym for Intra-Theater Message
<b>JPEG</b>	Acronym for Joint Photographic Experts Group, the international body that developed the JPEG 2000 standard

<b>KDM</b>	Acronym for Key Delivery Message
<b>KEK</b>	Acronym for Key-Encrypting Key
<b>Key</b>	Electronic data used to allow data encryption and decryption
<b>Key Epoch</b>	The period of time during which a given decryption key is valid. The key epoch defines a minimum practical time period for use of encrypted track files.
<b>kHz</b>	Acronym for kilo Hertz, one thousand cycles per second, a measure of frequency
<b>KLV</b>	Acronym for Key Length Value – used by the MXF to parse binary data
<b>LD</b>	Acronym for Link Decryption
<b>LDB</b>	Acronym for Link Decryption Block
<b>LE</b>	Acronym for Link Encryption
<b>LED</b>	Acronym for Light Emitting Diode
<b>Local Storage</b>	A storage device that is associated with an individual playback device
<b>Localizations</b>	Text on screen representing either non-source language dialog or information pertinent to the story such as time and place. This is specifically the text that is absent in text-less masters. This text is localized or translated for various markets either through subtitles or entire image replacement.
<b>LTC</b>	Acronym for Linear Time Code
<b>Main Titles</b>	A credit sequence generally shown near the beginning of a motion picture
<b>MB</b>	Acronym for Media Block
<b>MD</b>	Acronym for Media Decryptor, the device located in the Media Block that decrypts the compressed content.
<b>ME</b>	Acronym for Media Encryptor
<b>Metadata</b>	Data about data or data describing other data. Information that is considered ancillary to or otherwise directly complementary to essence. Information that is useful or of value when associated with the essence being provided.
<b>MTBF</b>	Acronym for Mean Time Between Failure
<b>MXF</b>	Acronym for Material eXchange Format
<b>NIST</b>	Acronym for National Institute of Standards and Technology
<b>NSA</b>	Acronym for National Security Agency
<b>NTSC</b>	Acronym for National Television System Committee, which developed the NTSC television broadcasting standard
<b>OAEP</b>	Acronym for Optimal Asymmetric Encryption Padding
<b>Open</b>	Referring to visual data that is supplemental to a motion picture being displayed on-screen
<b>Operational Pattern</b>	An MXF construct to define file structures



<b>Packing List</b>	A list describing the files and providing a means for authentication of the files as delivered in a package
<b>PAL</b>	Acronym for Phase Alternation by Line, a television broadcasting standard.
<b>Perceptual Coding</b>	Exploiting limitations in the HVS for data compression
<b>Playlist</b>	Conceptually, the format and structure of the various lists used to define the playback of content in Digital Cinema
<b>PNG</b>	Acronym for Portable Network Graphics, an extensible file format for the lossless, portable, well-compressed storage of raster images defined by the PNG Development Group.
<b>POC</b>	Acronym for Progression Order Change – see JPEG 2000 specification [ISO/IEC 15444-1]
<b>PPM</b>	Acronym for Packed Packet headers, Main header – see JPEG 2000 specification [ISO/IEC 15444-1]
<b>PPT</b>	Acronym for Packed Packet headers, Title-part header – see JPEG 2000 specification [ISO/IEC 15444-1]
<b>QCC</b>	Acronym for Quantization Component – see JPEG 2000 specification [ISO/IEC 15444-1]
<b>QCD</b>	Acronym for Quantization Default – see JPEG 2000 specification [ISO/IEC 15444-1]
<b>RAID</b>	Acronym for Redundant Array of Inexpensive Disks
<b>RAND</b>	Acronym for reasonable and nondiscriminatory
<b>Reel</b>	A conceptual period of time having a specific duration. A Reel is associated with track files. From a temporal view, the files making up a Reel are in parallel and are to be synchronized in their playback.
<b>Renewable</b>	A software component is renewable if it can be remotely, smoothly and possibly automatically upgraded or replaced without significantly disturbing system operations. A system shutdown and normal restart is acceptable, provided that after the restart, the system can be operated as before.
<b>Replaceable</b>	A component is said to be replaceable if it can be upgraded or replaced without significantly disturbing system operations. A system shutdown and restart is acceptable, provided that after the replacement, the system can be operated as before.
<b>RFC</b>	Acronym for Request For Comments
<b>RGN</b>	Acronym for Region of Interest – see JPEG 2000 specification [ISO/IEC 15444-1]
<b>RO</b>	Acronym for Rights Owner
<b>ROM</b>	Acronym for Read Only Memory
<b>RRP</b>	Acronym for Request Response Pairs
<b>SE</b>	Acronym for Security Entity, not to be confused with secure entity

<b>SECAM</b>	Acronym for System Electronique Couleur Avec Memoire, a television broadcasting standard
<b>Security Manager</b>	The controlling device of the security system in either the encoding, distribution or the theater playback process
<b>SHA1</b>	Acronym for Secure Hashing Algorithm 1
<b>Show</b>	The presentation that the audience sees and hears in the theater auditorium
<b>Show Playlist</b>	A Playlist of Composition Playlists and Event Playlists, describing a sequence that occurs at a particular screen. A Show Playlist is typically created by exhibition and transferred to the equipment controlling a particular screen.
<b>SM</b>	Acronym for Security Manager
<b>SMD</b>	Acronym for Subtitle Media Block
<b>SMPTE</b>	Acronym for Society of Motion Picture and Television Engineers
<b>SMS</b>	Acronym for Screen Management System
<b>SNMP/UDP/IP</b>	Acronym for Simple Network Management Protocol Over User Datagram Protocol Over Internet Protocol
<b>SPB</b>	Acronym for Secure Processing Block
<b>SPL</b>	Acronym for Show Playlist
<b>SPL</b>	Acronym for Sound Pressure Level
<b>Subpicture</b>	A multiple-image file format for the transport of visual data supplemental to a motion picture that is intended only for graphic overlay with the main image output of a digital projector
<b>Subtitle</b>	Text that is a representation, in a different language, of dialog occurring during scenes of a motion picture. Generally associated with dialog translation for localization of a motion picture in a particular territory.
<b>TCP/IP</b>	Acronym for Transmission Control Protocol / Internet Protocol
<b>TDES or 3DES</b>	Acronym for Triple Data Encryption Standard. TDES or 3DES was adopted as a federal standard in 1998 [FIPS (46-3)] and [ANSI standard X9.32]
<b>TDL</b>	Acronym for Trusted Device List. TDL correctly refers to the list within a KDM that enumerates those devices under the control of an auditorium's Security Manager (SM) that are trusted by the issuer of the KDM. TDL is sometimes incorrectly used to refer to those items within a database that enumerate the various subsystems of a given auditorium's installation.
<b>Timed Text</b>	Render text data onto a graphics overlay with the main image output of a digital projector
<b>TLM</b>	Tile-part Length, Main Header– see JPEG 2000 Specification [ISO/IEC 15444-1]
<b>TLS</b>	Acronym for Transport Layer Security

<b>TMS</b>	Acronym for Theater Management System
<b>Track File</b>	The smallest element of a package that can be managed or replaced as a distinct asset. A track file may contain essence and/or metadata, and its duration matches an associated Reel.
<b>UDP</b>	Acronym for User Datagram Protocol
<b>UL</b>	Acronym for Universal Label used in MXF
<b>Unicode™</b>	The Universal Multiple-Octet Coded Character set, the [ISO/IEC 10646:2003] standard that defines a single code for representation, interchange, processing, storage, entry and presentation of the written form of the world's major languages
<b>urn</b>	Acronym for uniform resource name
<b>USB</b>	Acronym for Universal Serial Bus, standardized serial communications connection found on computers
<b>UTC</b>	Acronym for Universal Coordinated Time
<b>UUID</b>	Acronym for Universal Unique IDentifier
<b>Visually Lossless</b>	An image compression method is considered visually lossless when the processed image is indistinguishable from the unprocessed image under normal theatrical viewing conditions.
<b>VPN</b>	Acronym for Virtual Private Network.
<b>VBR</b>	Acronym for Variable Bit Rate
<b>W3C</b>	Acronym for The World Wide Web Consortium, the organization responsible for the development of Internet protocols
<b>WWV</b>	Callsign of NIST's shortwave radio station in Fort Collins, Colorado. WWV's main function is the continuous dissemination of official United States government time signals
<b>XML</b>	Acronym for eXtensible Markup Language
<b>X'Y'Z'</b>	Tristimulus values defined by CIE in 1931 to represent colors. Prime indicates gamma corrected coordinates.